



New Jersey Department of Environmental Protection  
Division of Parks and Forestry  
State Park Service  
PO Box 420  
Mail Code 501-04  
Trenton, NJ 0862509420



# LIFEGUARD MANUAL

# STATE OPERATED OCEAN BEACHES

May 2021

## TABLE OF CONTENTS

Foreword .....	3
Required Reading for all NJ State Lifeguards .....	4

### PERSONNEL

I. Responsibility .....	6
II. Training.....	8
III. Public Relations .....	12
IV. Personal Injury on Duty.....	12
V. Pathogen Exposure .....	12
VI. Information and Guidelines on Sun Protection .....	15

### REGULATIONS

I. Personnel Regulations .....	22
II. Uniform Regulations .....	24
III. Flotation Devices .....	25
IV. Beach/Bathing Regulations .....	26
V. Enforcement of Beach & Bathing Regulations .....	27
VI. Windsurfing Regulations .....	27
VII. Disabled Ramp Regulations .....	28
VIII. Locker Room Regulations .....	28
IX. Public Informational Flags .....	28
X. Disciplinary Policy .....	29

### EQUIPMENT AND REGULATIONS AND USES

I. General Equipment Regulations .....	31
II. Lifeguard Stands.....	31
III. Portable Signs and Flags .....	32
IV. Kayaks .....	32
V. Rescue Boards .....	43
VI. Surf Boats .....	50
VII. Torpedo Buoys.....	55
VIII. Line Buoy .....	58
IX. Backboard and Cervical Collars .....	59
X. Pocket Masks and Bag Valve Masks .....	75
XI. Beach Wheelchair.....	75
XII. Personal Watercraft.....	76
XIII. All Terrain Vehicle.....	83
XIV. Mask, Fins, Snorkel .....	85
XV. Emergency Oxygen .....	86
XVI. AED .....	86

## PROCEDURES

I.	Opening and closing .....	88
II.	Communications .....	88
III.	Summoning Aid .....	92
IV.	Lost Child/Person .....	92
V.	Missing Child/Person .....	93
VI.	Red Alert Submersion.....	93
VII.	Off Beach Rescue/First Aid.....	96
VIII.	Disturbances .....	97
IX.	Lightning .....	97
X.	Guarding .....	98
XI.	Rescue Procedure and Coverage .....	101
XII.	Miscellaneous Hazards .....	105
XIII.	Rescue Without Lifesaving Equipment .....	107

## OCEAN BEACH TERMINOLOGY

I.	Ocean Water Terminology .....	110
ACKNOWLEDGEMENT .....		113

## **FOREWORD**

Lifeguards are responsible for the safety and wellbeing of the patrons who swim at their beach. To meet this responsibility, a lifeguard needs:

1. Knowledge of rescue procedures coupled with swimming ability.
2. A thorough familiarity with lifeguard equipment and the techniques used in its application.
3. The confidence to analyze and act effectively to situations either in the water or on the beach.
4. Trained eyes so that visual control can be maintained over the area of responsibility.
5. To be physically fit, to meet the physical demands of the job.

A lifeguard also has the responsibility to help ensure that each patron has the optimum opportunity to enjoy the public facilities.

The information contained within this manual is the result of years of experience, research, and practical application. It is based on common sense, and the basic components of open-water lifeguarding. The rules pertaining to the public are based on providing recreation, health, and safety for the majority. The personnel rules are not unreasonable. The rules are for the protection of the public and the lifeguards, while maintaining that degree of discipline necessary for the effective execution of a lifeguard's duties.

## REQUIRED READING FOR ALL LIFEGUARDS

1. Seasonal Employee Manual (State Park Service)
2. Lifeguard Manual (State Park Service)
3. American Safety and Health Institute Advanced First Aid for Non-EMS Personnel Student Handbook SKU: BKAFA-10N
4. American Health and Safety Institute Basic Life Support Student Handbook G2015 SKU: BKPRO-15N
5. American Health and Safety Institute Emergency Oxygen Student Handbook SKU: BKO2-10N
6. American Health and Safety Institute Bloodborne Pathogens Student Handbook SKU: BKBBP-15N
7. Lifeguarding Textbook (American Red Cross)  
ISBN 0-86536-181-9
8. Island Beach State Park Lifeguard Radio Procedures
9. Open Water Lifesaving USLA Manual Third edition  
1-323-58456-0

ASHI reading materials are available at [www.lifeforceusa.com](http://www.lifeforceusa.com)  
Mathew Giachetti <mat@lifeforceusainc.com>

# PERSONNEL

## I. RESPONSIBILITY

- A. Area Superintendent - The Area Superintendent is responsible for all activities within the area and is the highest authority.
- B. Water Safety Supervisor (WSS) - There is a Water Safety Supervisor in each region. This person assists the area Superintendents to ensure that all bathing areas are safely maintained and managed. As a member of the regional staff this position is directly responsible to the Regional Superintendent.
- C. Lifeguard Supervisor Captain - The Lifeguard Supervisor is responsible for maintaining a safe waterfront and transmitting orders, policies and procedures from the area Superintendent to the lifeguard staff. As administrative head of the lifeguard staff, the Supervisor is responsible for:
  - 1. Organizing, training, scheduling, and supervising the lifeguards
  - 2. Enforcing all rules and regulations
  - 3. Evaluating each lifeguard
  - 4. Beach management
  - 5. Maintaining required records
  - 6. Daily inspection of equipment and supplies
  - 7. Daily inspection of beach area, First Aid Room, and all facilities assigned to the lifeguards
  - 8. Reporting needed repairs or new/replacement equipment
  - 9. The morale of the lifeguards
  - 10. Reporting all safety and serious disciplinary problems to the area Superintendent
- D. Lieutenant -
  - 1. In the absence of the Supervisor, they perform the duties as outlined in “C” above.
  - 2. Carries out all tasks assigned by Supervisor.
  - 3. Responsible for efficient performance and training of lifeguards they are assigned to supervise.
  - 4. Responsible for safety and efficiency of assigned area.
  - 5. Carries out Lifeguard duties.
- E. Lifeguard Sergeant - Normal duties are:

1. Carries out orders issued by the Lieutenant and Supervisor.
2. Responsible for efficient performance and training of the lifeguards they are assigned to supervise.
3. Responsible for safety and efficiency of assigned area.
4. Carries out Lifeguard duties.

F. Lifeguard Duties -

1. Pass all sections of lifeguard employment test prior to being hired, except in cases when they are hired as lifeguard in training.
2. **Stay alert and scan patrons in the bathing area.**
3. **Safeguard and regulate the conduct of patrons in the bathing area to prevent conditions that may lead to an accident.**
4. Enforce beach and bathing area regulations.
5. Performs rescues, CPR and rescue breathing when necessary.
6. Performs first aid at a level consistent with ASHI Advanced First Aid except in the case of a broken bone or dislocation. In the case of broken bone or dislocation the lifeguard will keep the victim stationary and comfortable until the ambulance arrives. The ambulance crew will splint and move the victim. **ONLY** if the situation requires the lifeguard to move the victim immediately, the fractures must be immobilized.
7. Maintain and efficiently utilize lifeguard equipment.
8. Assist in maintaining a clean beach, employee area and First Aid Room.
9. Assist in maintaining records.
10. Meet training requirements.
11. Perform other duties as required or assigned.

G. Lifeguard/EMT First Aid Duties

1. Maintain first aid supplies in proper quantities and complete inventory every two weeks.
2. Check and refill first aid kits at the start of each day.
3. Maintain strict cleanliness in the first aid area.
4. Maintain first aid equipment in a clean, neat, and workable condition.
5. Keep the Lifeguard Supervisor informed on the status of first aid supplies and equipment.



6. Fill out and file a first aid report on all first aid administered.
  7. Review ASHI Advanced First Aid, BLS, Emergency Oxygen and Bloodborne Pathogens materials periodically throughout the season.
  9. Wear gloves while performing first aid or CPR. If the situation dictates, more protection (gown and face shield) must be worn.
- H. Unacceptable Lifeguard Conduct - Any let down in performance of duties that creates an unsafe situation, cannot be tolerated, and may lead to disciplinary action or dismissal.

## II. TRAINING

- A. First Aid/CPR - All lifeguards must have current American Red Cross Professional CPR/AED, First Aid, Bloodborne Pathogen, and Oxygen Administration certificates and/or American Safety and Health Institute BLS, Advanced First Aid and Bloodborne Pathogens certificates, and be competent in the use of backboards and cervical collars. These skills will be reviewed throughout the season during the in-service training.
- B. Physical - A lifeguard must meet physical training requirements each week.
1. The Lifeguard Supervisor will be responsible in seeing the physical training requirements and its records are carried out. The Lifeguard Supervisor may designate a physical training officer to administer physical training; however, the Lifeguard Supervisor is ultimately responsible.
  2. Each Lifeguard must complete physical training requirements each week. Substitution of one requirement for another is only permitted with prior permission of the Lifeguard Supervisor. On occasion a guard may be exempted from physical training requirements. EXAMPLE: Lifeguard did not work all 5 days or bathing area is closed.
  3. On occasion a guard may have to do more than the minimum requirements in a week.
  4. Physical training may only be done during working hours when it does not compromise the safety of the bathers.
  5. Lifeguards who work less than a 5-day week must complete a minimum of two training requirements per day.
  6. Failure to complete required training will result in disciplinary action or dismissal.
  7. Lifeguard officers may allow guards to perform exercises individually or conduct structured sessions that include all guards.
  8. Physical Training

## SWIM

Minimum is four 500-meter swims in at least 500-meter increments. When a Lifeguard swims a long distance from the bathing area or where boats may be present, extra safety precautions should be taken.

## PADDLE

Minimum is three 1000-meter kayak/rescue board paddles in at least 1000-meter increments

## RUN

Minimum is three miles a week in at least one-mile increments.

## ROWING

Minimum is one 1000-meter row completed all at once.

- C. Rescue Procedures and Techniques - All rescue techniques and emergency procedures will be learned. As much time as necessary will be spent in acquiring and maintaining proficiency in these skills.
- D. Lifeguards are responsible for knowing all procedures, skills, and regulations in the lifeguard manual and passing an examination on that manual. Any person caught cheating on the manual test will be dismissed.
- E. Lifeguards are responsible for all material in the Seasonal Employee Manual.
- F. The following outlines the training to be received by new guards. This material must be reviewed by returning lifeguards prior to carrying out lifeguard functions. All guards will review these skills and procedures throughout the season.

***ALL LIFEGUARDS ARE SUBJECT TO TESTING IN THE ABOVE SKILLS, AND THEIR PHYSICAL CONDITION, AT ANY TIME.***

# TRAINING PROGRAM

## ORIENTATION:

1. Objectives and Goals of Training Program
2. Using the lifeguard manual to achieve the objectives and goals of the training program.
3. Chain-of-Command and Scope of Authority
4. Introduction to Equipment and Facilities
  - a. Torpedo Buoys (rescue cans/buoys, torps)
  - b. Line Buoy
  - c. Kayaks/Rescue Board
  - d. Boats and Personal Watercraft
  - e. All-Terrain Vehicle
  - f. First Aid and CPR Equipment
  - g. Backboards and Related Equipment
  - h. Location of all Supplies and Equipment
  - i. Signs (Text, Location, Etc.) and Flags
5. Introduction to “Job of a Lifeguard”
  - a. Skills and performance required
  - b. Responsibility
  - c. Physical Fitness and In-Service Training
  - d. Preventative Lifeguarding
  - e. Public Relations
  - f. Enforcement of Beach & Bathing Area Regulations
  - g. Personnel Regulations
  - h. Disciplinary Policies
6. Communications
  - a. Hand and Whistle Signals
  - b. Telephone Procedures
  - c. Radio Procedures
  - d. Megaphone and Public Address Use
7. Environmental Hazards
8. Ocean & Beach Conditions

## Lifeguarding Skills and Procedures

1. Scanning
2. Rescue Procedures and Emergency Coverage
3. Rescues with equipment
  - a. Torpedo Buoy
  - b. Line Buoy

- c. Boat
  - d. Kayak/Rescue Board
  - e. Conscious Victims
  - f. Unconscious Victims, discuss in water rescue breathing with protection. (Ref. Open Water Lifesaving USLA Second Edition Pg. 264).
  - g. Multiple Victims
4. Rescues without equipment
    - a. Basic Fundamentals
    - b. Technique Variations
  5. Personal Watercraft (Designated Personnel Only)
    - a. Safety and Handling
    - b. Rescue Procedures
    - c. Off Beach Use
    - d. Maintenance
  6. All-Terrain Vehicle (Designated Personnel Only)
    - a. Safety and Handling
    - b. Recommended Uses
    - c. Off Beach Use
    - d. Maintenance
  7. Mask, Fins, Snorkel
  8. Water Search
  9. Submersion
  10. Lost and Missing Persons
  11. Emergency Care and Transportation of ill and injured
    - a. ASHI BLS, Emergency Oxygen and Bloodborne Pathogen training, Or State or NREMT EMT with BLS
    - b. ASHI Advanced First Aid, Or State or NREMT EMT with BLS Neck and Back Injuries in the Water
    - c. Review pages 360-361 Open Water Lifeguarding USLA Manual 3rd Edition in the unlikely event of having to interact with a helicopter. Pay particular attention to static electricity when lowering a cable and landing.

## Examinations

1. Written Examinations on all phases
2. Practical Examinations on all phases
3. Timed Swims

### III. PUBLIC RELATIONS

Lifeguards must remember that they work for a public service agency. They are to be courteous at all times. Personal contact with a patron is preferable to yelling, whistling or using a megaphone when possible. Lifeguards will enforce the rules for the area. Any difference of opinion will be referred to a lifeguard officer, other supervisor, area office, or State Park Police. Use of any offensive or obscene language by a lifeguard will not be tolerated. A lifeguard's conduct is a reflection upon the State of New Jersey, therefore lifeguards are expected to conduct themselves during duty hours and off duty hours in such a manner as to bring credit upon themselves, fellow employees, and the area in which they work.

### IV. PERSONAL INJURY WHILE ON DUTY

Whenever the service of a doctor, dentist, or hospital is needed because of an injury sustained while working, the area office must be notified prior to receiving services, when possible. The office will direct you to the nearest approved medical facility. If the facility is closed and urgent care is needed, proceed to the nearest hospital. Bills for doctors, the hospital, medication, etc., will be paid by the State of New Jersey in these cases. Check with the area office before paying with your own money or seeing a doctor of your choice. An employee First Aid Report must be filled out and signed by the immediate supervisor for any injury sustained on the job.

### V. BLOODBORNE PATHOGEN EXPOSURE

Pathogens are disease-causing agents such as bacteria, viruses and other agents that present themselves in blood and other potentially infectious materials (OPIM). Viruses include: Human Immunodeficiency (HIV), Hepatitis B, Hepatitis C, and others. OPIM are defined as semen, vaginal secretion, cerebrospinal fluid, synovial fluid, plural fluids, pericardial fluid, peritoneal fluid, amniotic fluid, unfixed tissues or organs, and any body fluids visibly contaminated with blood.

When a lifeguard is performing first aid, CPR or other duties, they may be exposed to Bloodborne Pathogen or OPIM.

- A. Pathogen exposure is defined as any contact with blood or OPIM of another person that may enter the body through a needle stick, open cut, sore, or mucous membranes such as eyes or oral cavities. Contact with saliva, urine, feces, vomit, or sputum visibly contaminated with blood is considered an exposure.
  1. If exposure occurs:
    - a. Immediately wash effected area with soap and water. Antiseptic may be applied if available. The sooner the contamination is washed off, the less chance of infection.
    - b. Immediately notify the area superintendent who must direct you to the

nearest hospital or medical facility for treatment. The superintendent will fill out a RM-2 and contact appropriate state offices.

- c. Go to approved medical facility immediately, explain exposure, and that this is a Workman's Compensation-related injury. If approved facility is closed or approved facility information is not available go to the nearest hospital. Do not delay.
2. When medical care has been completed for pathogen exposure the effected lifeguard must submit the following documentation from the medical provider to:

Office of Occupational Health and Safety  
(OOHS) PO Box 416  
Trenton, NJ 08625  
Fax: 609-984-2488

- a. That they have been informed of any medical testing results
- b. That they have been educated about medical conditions that can result from exposure to blood or OPIM.

B. To prevent pathogen exposure a lifeguard:

1. Will be trained in Red Cross and/or ASHI Bloodborne Pathogen and Disease Prevention along with OOHS Bloodborne Exposure Control Plan for State Lifeguards and OSHA Bloodborne Pathogen Regulation 29 CFR 1910. 1030. This training will be done yearly.
  - a. OSHA Bloodborne Pathogen standards are available online at: [www.state.nj.us/health/eoh/peoshweb/bbpslb.pdf](http://www.state.nj.us/health/eoh/peoshweb/bbpslb.pdf).
  - b. OOHS Complete Bloodborne Pathogen Exposure Control Plan for State Lifeguards is available at training and park office, in addendum of Lifeguard Administration and Procedures Manual.
2. Must always use universal precautions whenever contact with body fluids is anticipated. Universal Precautions requires the employer and employee to assume that all human blood and body fluids are infectious for HIV, Hepatitis, or other Bloodborne Pathogen.
3. Must always use Personal Protective Equipment (PPE) including disposable latex free gloves and resuscitation protective device when performing first aid, CPR, or whenever contact with body fluids or blood is anticipated. Gowns, and eye protection are also available.
4. Dispose of PPE after each use and each victim. The same PPE should not be used on multiple victims.
5. Hands should be washed if possible before providing care. Hands must be washed immediately following removal of gloves. If soap and water is not available other washing methods such as alcohol-based sanitizers

must be used. Sanitizers are only a temporary solution. Soap and water should be used as soon as possible. There shall be no eating, drinking, smoking, handling contact lenses, or applying cosmetics until hands are washed with soap and water.

C. Contaminated (Infected) materials, clothing, or regulated waste must be handled as followed:

1. Uniforms with any blood or body fluids from another person on them must be discarded. Do not attempt to wash or clean.
2. Non-disposable contaminated materials (backboard, floor, etc.) must be cleaned, then sanitized with diluted bleach (12 ounces bleach to 1 gallon of water). The bleach solution should stand for at least 10 minutes then be wiped dry.
3. To dispose of any materials completely saturated with blood or body fluids (Saturated means if the material was squeezed fluid would escape), follow the procedures below:
  - a. Give saturated material to ambulance. They have a bag for this material. The ambulance disposes of material at the hospital.
  - b. If an ambulance does not respond to first aid and blood saturated materials must be disposed of. The State Park Police must be contacted for disposal (Ambulance is first option)
  - c. Unsaturated materials (like some blood on gauze, band-aid, etc.) is thrown in regular trash.
4. Do not touch syringes or any medical waste found on beach or bathing complex State Park Police must be notified for disposal. Keep public away from material. Park Police must notify NJ DEP Communication Center of incident.

D. Hepatitis B Immunization

All lifeguards will be offered a free Hepatitis B vaccination when hired. This immunization is not mandatory.

1. All lifeguards must complete the Hepatitis Immunization Form, every year to indicate acceptance, refusal, or already received immunization.
2. Lifeguards who have already received immunization and want to be tested for effectiveness of previous immunization may request a titer on the Hepatitis immunization form.
3. The vaccine is prepared from recombinant yeast cultures rather than human blood and as a result there is no risk of contracting the Hepatitis B Virus from the vaccine.
4. The Park superintendent will notify you of the date and time you are to receive

injection 1 and 2 of the immunization series. This is considered a work assignment and you will be provided transportation.

5. Injection 3 is 5 months after injection 2. The 3<sup>rd</sup> injection is scheduled in December or January. At this time the lifeguard is no longer an employee of the state of New Jersey. As a courtesy the third injection is free of charge. However, the lifeguard is responsible to call OOHS at 609-292-1408 to schedule injection 3. The lifeguard is responsible to supply their own transportation for injection 3. Lifeguards may elect to have their own physician administer the 3<sup>rd</sup> injection. If that is the case, documentation is required and must be sent to:

OOHS  
PO Box 416  
Trenton, NJ 08625-0416

6. If a lifeguard declines immunization when employed they may request vaccination at a later date.

VI. INFORMATION AND GUIDELINES ON SUN PROTECTION - EACH LIFEGUARD WILL BE ISSUED SUNSCREEN AND POLARIZED SUNGLASSES WITH UV PROTECTION.

- A. The following information is reprinted from the pamphlet “The Sun and Your Skin” with permission of the American Academy of Dermatology, P.O. Box 4014, Schaumburg, Ill. 60168-4014.

**“The Sun and Your Skin”**

Soaking up the sun’s rays used to be considered healthy before we learned about the dangers of ultraviolet rays.

Sunlight can be used to treat some skin diseases, but we all need to avoid overexposure to the sun. Too much sun can cause wrinkles, freckles, skin texture changes, dilated blood vessels and skin cancers. It may also cause other problems.

**The Sun’s Rays**

The sun produces both visible and invisible rays. The invisible rays, known as ultraviolet- A (UVA) and ultraviolet-B (UVB), cause most of the problems. Both cause suntan, sunburn and sun damage. There is no “safe” UV light.

Harmful UV rays are more intense in the summer, at higher altitudes, and closer to the equator. For example, Florida receives 150% more UV than Maine. The sun’s harmful effects are also increased by wind and reflections from water, sand and snow. Even on cloudy days UV radiation reaches the earth.

**Protection from the Sun**

Using sun protection will help prevent skin damage and reduce the risk of cancer.



The American Academy of Dermatology recommends that you avoid deliberate sunbathing, wear a wide-brimmed hat, sunglasses and protective clothing and if you must be in the sun, use a sunscreen with a sun protection factor (SPF) of at least 15, even on cloudy days.

Sunscreens work by absorbing, reflecting or scattering the sun's rays on the skin. They are available in many forms, including ointments, creams, gels, lotions and wax sticks. All are labeled with SPF numbers. The higher the SPF, the greater the protection from sunburn, caused mostly by UVB rays. Some sunscreens, called "broad spectrum," block out both UVA and UVB rays. These do a better job of protecting skin from other effects of the sun, including rashes. Sunscreens are not perfect, however. Sun protection should always start with avoiding peak sun hours and dressing sensibly.

Sunscreens should be applied about 20 minutes before going outdoors. Even water-resistant sunscreens should be reapplied often, about every two hours or after swimming or strenuous activities.

Beach umbrellas and other kinds of shade are a good idea, but they do not provide full protection because UV rays can still bounce off sand, water and porch decks. Remember, UV rays are invisible.

Most clothing absorbs or reflects UV rays, but white fabric like loose-knit cotton and wet clothes that cling to your skin do not offer much protection. The tighter the weave, the more sun protection it will offer.

### **Effects of the Sun**

**Sunburn** - Your chances of developing sunburn are greatest between 10 am and 4 pm, when the rays of the sun are strongest. It's easier to burn on a hot day, because the heat increases the effects of UV rays.

Sun protection is also important in the winter. Snow reflects up to 80 percent of the sun's rays, causing sunburn and damage to uncovered skin. Winter sports in the mountains increase the risk of sunburn because there is less atmosphere to block the rays of the sun. If skin is exposed to sunlight for too long, redness may develop and increase for up to 24 hours. Severe sunburn causes skin tenderness, pain, swelling and blistering. Additional symptoms like fever, chills, upset stomach and confusion indicate serious sunburn and require immediate medical attention. If you develop a severe sunburn or begin to develop a fever, your dermatologist may suggest medicine to reduce swelling, pain, and prevent infection.

Unfortunately, there is no quick cure for minor sunburn. Wet compresses, tub baths and soothing lotions may provide some relief.

**Tanning** - A tan is often mistaken as a sign of good health. Dermatologists know better. A suntan is actually the result of skin injury. Tanning occurs when UV rays enter the skin and it protects itself by producing more pigment or melanin.

Indoor tanning is just as bad for your skin as sunlight. Most tanning salons use ultraviolet-A bulbs and studies have shown that UVA rays go deeper into the skin and contribute to premature wrinkling and skin cancer.

**Aging** - People who work outdoors or sunbathe without skin protection can develop tough, leathery skin, making them look older than they are. The sun can also cause large freckles called “age spots” and scaly growths (actinic keratoses) that may develop into skin cancer. These skin changes are caused by years of sun exposure. Protecting children from the sun is especially important, since most of our lifetime exposure occurs before the age of 20.

**Skin Cancer** - More than 90 percent of all skin cancers occur on sun-exposed skin. The face, neck, ears, forearms and hands are the most common places it appears.

The three most common types of skin cancer are basal cell carcinoma, squamous cell carcinoma and melanoma.

Basal cell carcinoma usually develops on the face, ears, and lips and around the mouth of fair-skinned individuals. It can start as a red patch or shiny bump that is pink, red or white. It may be crusty or have an open sore that does not heal or heals only temporarily. This type of cancer can be cured easily if treated early.

Squamous cell carcinoma usually appears as a scaly patch or raised, warty growth. It also has a high cure rate when found and treated early. In rare cases, if not treated, it can be deadly.

Melanoma is the most dangerous form of skin cancer. It usually looks like a dark brown or black mole-like patch with irregular edges. Sometimes it is multicolored with shades of red, blue or white. This type of skin cancer can occur anywhere on the body and when found early, can be cured. If ignored, it spreads throughout the body and can be fatal.

**Allergic Reactions** - Some people develop allergic reactions to the sun. These reactions may show up after only a short time in the sun. Bumps, hives, blisters or red blotches are the most common symptoms of a sun allergy. Sometimes these reactions are due to cosmetics, perfumes, plants, topical medications or sun preparations. Certain drugs, including birth control pills, and blood pressure, arthritis and depression medications can cause a skin rash with sun exposure. If this occurs, a dermatologist can help.

**Diseases** - Some diseases can be made worse by the sun, including cold sores, chickenpox and a number of less common disorders such as lupus erythematosus.

UV rays also can cause cataracts, a gradual clouding of the lens of the eye.

### **Tips for Sun Protection**

1. Use a broad-spectrum sunscreen with an SPF of at least 15 on all exposed skin, including the lips, even on cloudy days.

2. Reapply sunscreen frequently.
3. Wear a broad-brimmed hat and sunglasses.
4. Sit in the shade whenever possible.
5. Wear protective, tightly woven clothing.
6. Plan outdoor activities early or late in the day to avoid the peak sunlight hours of 10 am to 4 pm.

Everyone should be able to enjoy sunny days. By using a little common sense, as well as the guidelines developed by the American Academy of Dermatology, you can safely work and play outdoors without worrying too much about skin cancer or wrinkles.

- B. The following information on protecting your eyes is from the pamphlet “Sunglasses Are More Than Shades”. It is reprinted with permission of the American Optometric Association, 243 North Lindbergh Blvd., St. Louis, Missouri 63141. You are probably aware of the danger posed by UV radiation to your skin, but you may not realize that exposure to UV radiation can harm your eyes and affect your vision as well.

### **“Sunglasses Are More Than Shades”**

#### **Effects of Ultraviolet Radiation**

In addition to visible light, the sun gives off two other types of radiation, infrared (IR) and ultraviolet (UV). The effects of infrared radiation are less known but are thought to be harmless to the eyes. UV radiation is divided into UV-A, UV-B, and UV-C, UV-C is absorbed by the ozone layer and does not present any threat (man-made sources of UV-C, like electric welding arcs, are very harmful to the eyes if you do not wear proper protection).

Mounting scientific evidence shows long-term exposure to both UV-A and UV-B can contribute to the development of cataracts; retinal problems; benign growths on the eye’s surface; cancer of the eyelids and skin around the eyes; and photokeratitis, a temporary, but painful sunburn of the eye’s surface (sometimes called snow blindness or welder’s flash).

#### **Glare Protection**

Disability glare is associated with the sun’s brightness, and it interferes with your comfortable vision and our ability to see clearly. It causes you to squint and your eyes to water. Disability glare can occur on both sunny and cloudy days and sunglasses that screen out 75 to 90 percent of available light are effective in reducing the brightness and the effects of disability glare.

When the sun’s light bounces off snow, water, sand or highway pavement, reflected glare occurs. Polarizing sunglasses are more effective at eliminating reflected glare than ordinary sunglasses.

Reducing glare makes driving as well as outdoor recreational and occupational activities safer and more comfortable and productive.

### **Choosing the Right Sunglasses**

There are a number of options that you can consider when purchasing sunglasses. Here are some:

- Polarizing lenses effectively reduce reflected glare, sunlight that bounces off smooth surfaces such as water or pavement. They are particularly useful for driving, boating and lifeguarding.
- Photochromic lenses darken or lighten with the amount of light available.
- Mirror coatings reflect rather than absorb light and are primarily for wear under intense glare from snow or water.

No matter what sunglass styles or options you choose, you should insist that your sunglasses:

- Block out 99-100 percent of both UV-A and UV-B radiation
- Screen out 75-90 percent of visible light (fashion tinted lenses usually do not meet this level);
- Are perfectly matched in colors and are free of distortion and imperfection.
- Have lenses that are gray, green or brown (gray is recommended).

If you wear your sunglasses for eye hazardous sports or work, you should choose polycarbonate lenses. These lenses provide the greatest available impact protection.

Wrap-around sunglasses, which are shaped to keep light from shining around the frames can be worth considering, particularly if you spend a lot of time outdoors in bright sunlight.

Wearing a wide brimmed hat provides additional protection from UV radiation.

### **Purchasing Sunglasses Can Be Complicated**

It can be difficult to be certain the sunglasses you purchase are right for you because there are no federal sunglass regulations regarding UV radiation and visible light transmission levels, and lens quality. And don't be confused. Price is not necessarily a gauge of lens quality or UV blockage.

Here are some ways to judge non-prescription sunglass quality:

- Check lenses to be sure the tint is uniform, not darker in one area than another. (Except gradient density lenses).

- Hold glasses at arm's length and look through them at a straight object. Slowly move the lens across the object. If the edge of the object distorts, sways, curves or moves, the lens has imperfections.
- To be sure the lenses block enough light, try them on in front of a mirror. If you can see your eyes clearly through the lenses, they probably are not dark enough for glare reduction and comfort. This test does not apply to photochromic lenses.
- Ask your optometrist to help you check your lenses' UV protection capabilities, to suggest which options are most appropriate for your needs and to help you decide which sunglasses are best for you.

# **REGULATIONS**

## I. PERSONNEL REGULATIONS

- A. No person other than a member of the lifeguard staff will assume the duties of lifeguard at any time.
- B. A lifeguard must be on duty on a stand at all times when there are bathers or potential bathers in the beach area, during assigned guarding hours.
- C. Lifeguards are to remain at their assigned positions at all times until properly relieved, unless an emergency occurs.
- D. Lifeguards are not to sit anywhere other than on the assigned stand when on stand duty. This includes the beach area adjacent to the stand.
- E. Lifeguards must satisfactorily complete all training requirements.
- F. A lifeguard is not to accept, in any form, remuneration for lifeguard services rendered while in the employ of the State of New Jersey, except a paycheck.
- G. Lifeguards will perform all duties and responsibilities promptly.
- H. Lifeguards are to enforce the beach and bathing area rules at all times with impartiality.
- I. Lifeguards are to be courteous at all times.
- J. Lifeguards have complete authority and responsibility for the bathing area assigned to them. They are not to take orders or directions from anyone except their beach supervisor, or other supervisor, who has been given authority to do so by the chain-of-command within the area, region, or state.
- K. A lifeguard is not to strike another person except in defense of his/her own person
- L. Lifeguards are to report all incidents and first aid cases of a serious nature to the area Superintendent through the chain-of-command.
- M. While on duty, a lifeguard may not be under the influence of or consume any form of alcoholic beverage or controlled substance. A lifeguard taking medication must get a written statement from his/her physician stating they can perform all of their duties. Violations may result in suspension or dismissal.
- N.1. A lifeguard's personal appearance must conform to standards as established in the State Park Service Seasonal Employee Manual, this Manual and as established by the Area Superintendent.
- N.2. Jewelry that could pose a safety issue or objectionable attire shall not be worn. Medical alert medals and

wrist watches are not considered jewelry. A medical alert medal must be taped securely. Wristwatches must be securely fastened. This regulation is for your safety and the safety of the public.

- O. Lifeguards are not to engage in conversation with patrons that may be construed as detrimental to any individual, or to the system in which they are employed. Complaints or grievances should be addressed to supervisors through the chain-of-command.
- P. Lifeguards will not make any verbal, written, internet or media statements regarding any park related incident or information without the permission of the Superintendent.
- Q. No person other than a lifeguard may sit on a lifeguard stand at any time, except in the case of a lost child.
- R. Lifeguards will not further social relationships while on duty.
- S. Lifeguards are not to cease bathing operations without permission from the area Superintendent through the chain of command except in an emergency. If such an emergency occurs, the area Superintendent will be notified as soon as possible.
- T1. Lifeguards are not to render any medical treatment or advice other than ASHI Advanced First Aid or BLS unless certified by the NJ Department of Health and Senior Services as an EMT. An EMT may carry out any care specified by their certification. An EMT must submit a copy of EMT certification for his/her personnel files.
- T2. Lifeguards not currently certified in CPR or First Aid should not perform these functions.
- U. Lifeguards will not allow any beach patron to treat a victim under his or her care. The victim will only be turned over to the local first aid squad or paramedics upon their arrival.
- V. Lifeguards are not to dispense any first aid supplies other than in the performance of their duty.
- W. Lifeguards are not to eat, loiter or congregate in the first aid area. Lifeguards are not permitted to smoke while on active duty or in public view.
- X. All lifeguards must be available in the event of any emergency as determined by the Lifeguard Supervisor or the area Superintendent. During breaks other than lunch, a Lifeguard must remain alert in the vicinity of the beach area.
- Y. Lifeguards are expected to treat their co-workers and supervisors with respect and exercise every consideration in their relationships to assure maximum area efficiency. All area personnel are expected to work together as a team to achieve this end result.



- Z. Lifeguards must adhere to their weekly work schedules unless they have sufficient cause, such as illness, death in the immediate family, etc. The area supervisor must be notified of any absence at least 30 minutes before your scheduled starting time.
  - A.A. Lifeguards will enter shallow or unfamiliar water outside the bathing area feet first and cautiously.
  - A.B. Lifeguards are required to wear polarized sunglasses with UV protection except in low light conditions.
  - A.C. A lifeguard may request professional counseling if stressed by an incident. The Park Superintendent is the contact person.
  - A.D. The use of personal electronic devices, such as cell phones, is not permitted during working hours, unless required for official communication or during unpaid lunch breaks.
  - A.E. A lifeguard will practice social distancing to take precautions against the spread of COVID.
  - A.F. A lifeguard will wear a mask at all times while in buildings and will take necessary precautions against the spread of COVID.

## II. UNIFORM REGULATIONS

Adhering to the following uniform regulations is a condition of employment. Failure to comply with the following regulations will be considered insubordination and is subject to disciplinary action.

- A. Only State issued uniforms and approved uniform items may be worn when working as a lifeguard.

All required lifeguard uniform components will be issued by the State Park Service as follows:

1. Male swimsuit (RED) with Division logo.
2. Female swimsuit (RED) with Division logo.
3. T-shirt (WHITE) with Division logo.
4. Hat with Division logo.
5. Rain Parka (RED) with Division Logo. This uniform component is an “area” issue and not an “individual” issue.

- B. The only clothing a lifeguard may wear other than the State issued uniform is a State Park Service approved women’s two-piece swimsuit, sweatshirt, sweatpants, a wide brim hat and approved sun protective clothing. The only swimsuits, sweatshirts, sweatpants and wide brim hat permitted must be purchased from the NJ State Park Service or State Park Service approved vendor. A lifeguard may use their own unmarked light

gray sweatsuit with NJ State Park Service patches sewn on the left leg and left breast area. The approved sun protective clothing is white long sleeve shirt and white pants. A NJ State Park Service patch must be sewn onto clothing. A list of sun protective clothing manufacturers may be obtained from your Superintendent or Water Safety Supervisor. NJ State Park Service patches are requested from your Water Safety Supervisor.

- C. The uniform items shall only be worn while on duty performing lifeguard functions or traveling to and from work.
- D. It is suggested that lifeguards wear uniform shirt when not in the water.
- E. Uniform items will not be changed, altered, or modified in any way.
- F. All uniform items are to be clean and in good repair at all times.
- G. All uniform items are not to be traded or loaned.
- H. All uniform items are not to be worn by anyone other than lifeguard personnel.
- I. Any loss or damage to uniform items is to be reported immediately through the chain-of- command.
- J. Any necessary uniform exchanges or replacements are to be requested through the chain-of- command.
- K. Any damage or loss of State-provided uniform items or other lifeguard equipment that results from the fault or negligence of any lifeguard will result in monetary reimbursement to the State by involved employee(s).
- L. Whistles and lanyards will be worn around the neck at all times when on duty.
- M. No sneakers or shoes other than water shoes may be worn while on lifeguard stand.
- N. When off the lifeguard stand, shoes or sandals should be worn whenever possible (breaks, bathroom, etc). Foot injuries are the #1 lifeguard injury.

### III. FLOTATION DEVICES

The prohibition of flotation devices (including U.S. Coast Guard Approved PFD's) on state operated ocean beaches is a policy made to ensure water safety. A large number of drownings each year in the United States may be attributed, either directly or indirectly, to the use of flotation devices. The only form of flotation device approved for use in bathing areas is a surf mat of heavy construction (canvas cover, air filled), and the body board. The body board must have a leash and be without skegs. These mats and body boards may only be used in areas designated for that purpose within ocean swimming areas. If a disabled patron must use an unapproved flotation device, this individual must be referred to the Superintendent. The Superintendent may approve an unapproved flotation device for a disabled person using the procedure found in Chapter 10 of the Lifeguard Administrative and Procedural Manual. The following are some of the factors considered in establishing the policy prohibiting the use of flotation devices:

- A. They offer a bather a false sense of security, and often prompt non-swimmers to venture into water over their heads. A lifeguard cannot evaluate the swimming ability of a bather with a flotation device.
- B. If a strong wind or current is moving away from the beach, bathers, and especially small children, are likely to drift because use of arms for propulsion is difficult with a flotation device on.
- C. The flotation device may be blown out of reach of the bather if it is momentarily released, or if the bather should fall off or out of the device.
- D. All inflated objects are subject to leaks and punctures.
- E. If a bather is knocked off their feet, any device positioned around the waist may prevent the bather from regaining his/her footing.
- F. It is difficult for a bather with a flotation device to duck under waves. This difficulty could result in a spinal injury.

#### IV. BEACH AND BATHING AREA REGULATIONS

Within the confines of the beach and the bathing area, there shall be no:

- A. Ball or frisbee playing (in other than designated areas).
- B. Fires.
- C. Consumption of alcoholic beverages.
- D. Kite flying.
- E. Nudity.
  - E.1. Breast feeding is permitted; breastfeeding is exempt from public indecency laws.
- F. Dogs, other than service animals.
- G. Use of snorkels by other than lifeguard personnel.
- H. Horseplay that may result in injury.
- I. Scuba diving, unless approved by the area office.
- J. Loud radios, or other electronic devices.
- K. Bathing or swimming outside of the bathing area.
- L. Fishing when the bathing area is open to public recreational bathing.
- M. Glass Containers.
- N. Spitting.

- O. Bathing by people under the influence of drugs or alcohol.
- P. Profane Language.
- Q. Children in diapers in the water, unless diapers are covered by plastic pants with snug fitting elastic waist and leg bands.
- R. Feeding of geese, seagulls or other birds.
- S. Boats within 200 feet of bathing area. The area where boats are excluded is marked with buoys.
- T. Metal detector use on beach and in bathing area between 10 am and 6 pm. For use of metal detectors at other times refer patron to park office.
- U. Remaining on the beach during electrical storms or beach closures.

V. ENFORCEMENT OF BEACH AND BATHING AREA REGULATIONS

- A. The enforcement of all rules and regulations within the designated bathing area is the responsibility of the assigned lifeguards.
- B. The assistance of the State Park Police, or the area Superintendent, is to be requested if a condition arises that is beyond the ability of a lifeguard to resolve, i.e. drunk and disorderly behavior, weapons in the beach area complex, etc.
- C. A lifeguard will not jeopardize the safety of bathers by leaving the bathing area to tend to patrons breaking rules outside of the bathing area.

VI. WINDSURFING REGULATIONS

- A. Windsurfing is permitted south of the bathing area (adjacent to the Surfing Beach).
- B. Windsurfing is permitted from 10:30 am to 5:30 pm.
- C. WINDSURFERS MUST OBEY AREA PERSONNEL AND FOLLOW ALL RULES AND REGULATIONS. The State Park Service reserves the right to suspend access due to prevailing conditions.
- D. The windsurfing area will be limited to an approximate 20-meter beach front/launch area. This area will extend approximately 800 meters from shore. Once outside the marker buoy, windsurfers may travel north to the northernmost buoy. Windsurfing is not permitted on the bayside of the area and is limited to the designated area on the oceanfront.
- E. All launches and landings must be in the designated Windsurfing Area.

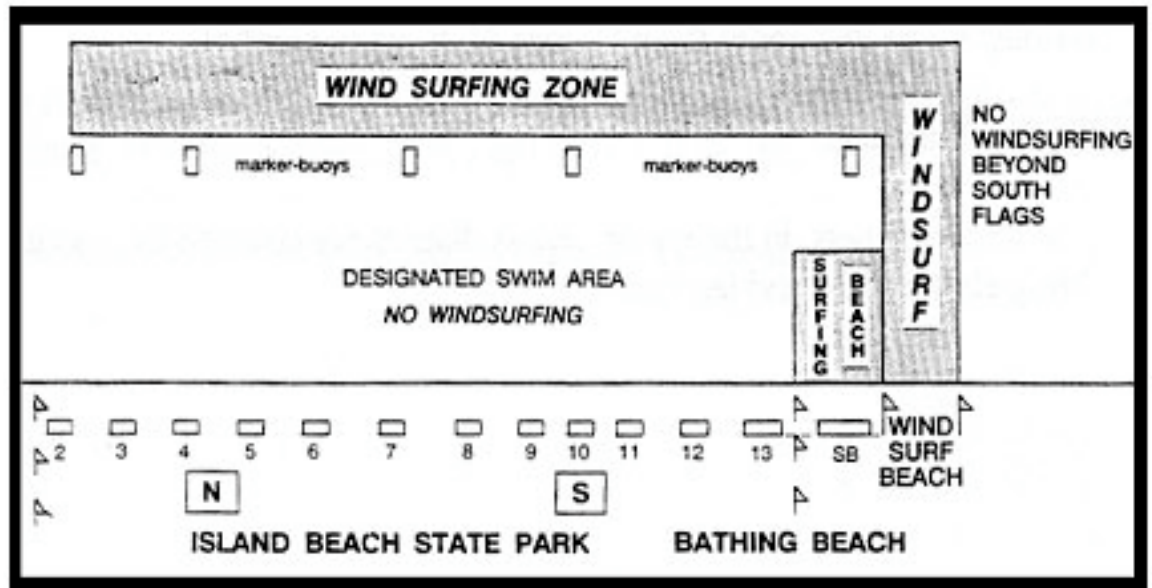

VII. DISABLED RAMP REGULATIONS

- A. Maintain daily to ensure a smooth, even path.
- B. Must be moved in case of high surf conditions or pending storm.
- C. Notify lifeguard officers if the ramp is damaged or unsafe.
- D. Surf wheelchairs are available for use by patrons. Surf wheelchairs may only be used to transport people.

VIII. LOCKER ROOM REGULATIONS

- A. Locker Room may be used by employees during working hours.
- B. Locker Room will be swept clean each day of sand and litter.
- C. All waste cans shall be emptied and relined with a clean waste bag daily.
- D. Facilities will be secured each day after closing.

IX. PUBLIC INFORMATIONAL  
FLAGS

This flag system informs the public if lifeguards are on or off duty, along with ocean conditions.

- A. Flags will be posted at the main gate, swimming areas and north and south towers.
- B. Flag Code

1. One Red Flag - Lifeguards are off duty. NO SWIMMING.
2. Green Flag Over Green Flag - Lifeguards are on duty and the ocean is calm.
3. Green Flag Over Yellow Flag - Lifeguards are on duty, ocean conditions are potentially hazardous and bathers should use caution.
4. Green Flag Over Red Flag - Lifeguards are on duty and ocean conditions are extremely dangerous.

C. The Senior Lifeguard Officer will determine which colored flag will fly.

X. DISCIPLINARY POLICY

Failure of a lifeguard to carry out any personnel, uniform or beach regulations will result in disciplinary action or dismissal.

# **EQUIPMENT REGULATIONS AND USES**

## I. GENERAL EQUIPMENT REGULATIONS

All equipment is the property of the State of New Jersey.

### A. Use

State owned equipment will only be used in the prescribed manner. It will not be used in any manner that will create a hazard to any person. Unauthorized persons will not be allowed to use lifeguard equipment.

### B. Inventory

An inventory of all state-owned lifeguard and lifeguard related equipment is to be submitted by the Lifeguard Supervisor to the area Superintendent before opening day, and again on or before October 10th, of each year. All inventories are to be listed on designated inventory sheets. In addition to inventories for Superintendent, inventories will be taken regularly lifeguard records. Any deficiencies discovered should be addressed.

### C. Damage or Loss

All equipment is to be inspected daily. All damage or loss is to be reported to the area Superintendent immediately. Equipment is not to be loaned, given away, destroyed, or otherwise dispensed with, regardless of condition, without the permission of the Superintendent. Any non-usable piece of equipment is to be reported to the regional Water Safety Supervisor (WSS) in addition to the Superintendent.

### D. Acquisition

Equipment is not to be purchased by any individual for, or on behalf of, the State of New Jersey without the permission of the area Superintendent. A piece of equipment not presently available, that will improve efficiency, may be recommended for purchase to the Lifeguard Supervisor.

### E. Repair

Any repairs of lifeguard equipment that cannot be accomplished within the area will be reported to the area Superintendent. Any repairs requiring the expenditure of money will also be reported to the area Superintendent.

## II. LIFEGUARD STANDS

Regulations

- A. Stands should always be as close to the water's edge as is practical. Stands will not be more than 30 feet from water.
- B. One stand should not cover more than 300 feet of beach.
- C. Every stand should have a minimum of one torpedo line buoy per stand and two torpedo buoys.



- D. Kayaks/Rescue Boards should be distributed to stands so the equipment is balanced over the length of the beach
- E. Each stand should have a First Aid Kit containing bandages, dressings, band-aids, gloves, pocket mask, ice packs and BVMs. Additional bag valve masks (adult and child) will be kept with the oxygen in the first aid rooms.
- F. Articles of clothing or personal effects should never be hung or draped over the back of stands.
- G. Patrons are not allowed to loiter in front of the stands.
- H. Stands are not to be opened or closed down without permission of the senior lifeguard officer.
- I. Lifeguard stands will be staffed when any patron(s) are in the water or on the beach during normal operating hours.
- J. When possible, stands are to be laid down when not in use.
- K. Stands should be examined for damage at the beginning and end of each day. All damage should be reported immediately through the chain-of-command.
- L. Area in front of stand should be clear of the public's blankets and umbrellas. If an umbrella is in your line of sight, it must be moved.

### III. PORTABLE SIGNS AND FLAGS

Flags are used to mark the ends of the bathing area and danger areas. Red flags mark "No Swimming" and can be used to mark "Danger Areas." Danger areas may also be marked with rip current signs.

- A. Regulations
  - 1. Flags are to be used only in prescribed manner.
  - 2. Flags, poles and signs are to be kept in an excellent state of repair. Tattered flags should be reported for replacement immediately.
  - 3. The placement of the flags on the beach will be determined each morning by the senior lifeguard officer.
  - 4. Flags are not to be moved at any time during the day without the permission of the senior lifeguard officer.

### IV. KAYAKS

Lifeguard kayaks are open-top kayaks that are twelve (12) feet long and weigh about forty-five pounds. Kayaks are a highly efficient method of patrolling and bringing victims to shore. One or two victims can be put on top of the kayak. The kayak will support numerous victims hanging from the side of the kayak.

A. Regulations

1. Kayaks not in use are to be kept next to the lifeguard stand.
2. Kayaks should be distributed evenly on the beach.
3. When using the kayak, dragging it along the beach should be kept to a minimum.
4. All kayaks will be equipped with an asymmetric paddle.
5. Water should be emptied through the drainage hole at least once a day.
6. Any damage to the kayak or its equipment should be reported through the chain-of-command immediately. This way repairs can be made as quickly as possible.
7. Be careful not to run over anyone with kayak.
8. Be careful not to hit anyone with kayak paddle.

B. Use of Kayak

1. When to use:
  - a. For deep water patrol.
  - b. Rescues where long distances must be covered.
  - c. Rescues with multiple victims.
  - d. Rescues where large amounts of debris or weeds are present.
  - e. To assist capsized or disabled boats, provided the bathing area is sufficiently protected.
2. When not advisable to use:
  - a. Within crowded areas.
  - b. On rescues that require the kayaks to be carried long distances.
  - c. On rescues inside the surf line.
  - d. Large surf.
  - e. When the lifeguard is not proficient for the ocean conditions present, a rescue buoy is recommended.

C. Paddling the Kayak (P-1K)



**P-1K**

1. Grip the paddle from above and a little wider than shoulder width.
2. The center of the paddle should be at the height of your neck.
3. Sit up straight.
4. Keep your shoulders square. Your shoulders should not be swinging back and forth or dipping down while paddling.
5. Grip the paddle tightly with your dominant hand. The paddle should rotate in your non-dominant hand. Your non-dominant hand only grips the paddle tightly when taking a stroke on that side.
6. The power of your stroke is 60% push and 40% pull.
7. Kayak should be kept perpendicular to the waves at all times to avoid capsizing.
8. Obtain as much speed as possible before going through a wave.
9. Lean back and hold paddle over your head when going through a wave (P-2K).
10. As a wave passes, lean forward and paddle.
11. Legs can be secured with leg straps when paddling through waves.



**P-2K**

D. Turning the Kayak

1. Backstroke on the side you want to turn to, followed by a front stroke on the opposite side if needed. Continue this pattern until the desired direction is achieved.

E. Stopping the Kayak

1. Back paddle, alternating sides.
2. Turn stroke.
3. Bail out and hold onto the kayak.

F. Getting to the Victim in the Ocean

1. Entering the Ocean

- a. Drag kayak into ocean using rope handle on the bow. It is best to enter ocean during a lull (P-3K).



**P-3K**

- b. Rescuer pulls kayak to his/her side while putting one hand on opposite side of the kayak for stability. Now just sit in kayak and begin paddling (P-4K).

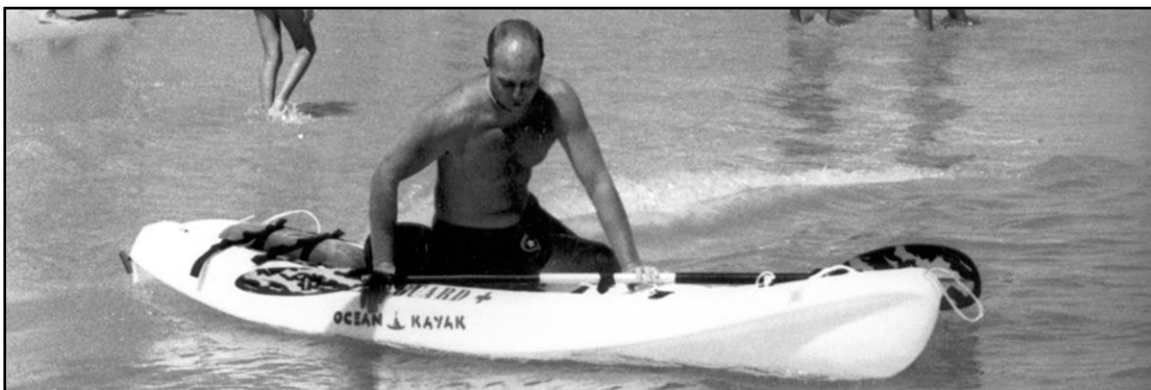

**P-4K**

2. Paddling to Victim
  - a. Keep eye contact with the victim.
  - c. Follow previous directions for paddling kayaks.

G. Making the Rescue

1. Tired Swimmer Rescue

- a. Rescuer approaches so the victim is on the side of the kayak. Rescuer will straddle kayak for more stability and move forward to assist the victim (P-5K).



**P-5K**

- b. Instruct victim to grab side of kayak, then pull victim's arms across front of kayak (P-6K).



**P-6K**

- c. Ask victim to kick his/her legs while pulling victims chest and shoulders into kayak (P-7K).



**P-7K**

- d. Swing victim's legs into kayak (P-8K).



**P-8K**

- e. Rescuer moves behind normal paddling position for better balance and paddles victim to shore (P-9K).



**P-9K**

- f. An alternative to bringing a tired swimmer aboard the kayak is to have the victim hang from the bow of the kayak while paddling the victim to safety (P-10K). It is more difficult to paddle with the victim hanging from the kayak but it may be more practical for a short distance or a large victim.



**P-10K**

2. Unconscious Victim

- a. Approach so the victim is on the side of the kayak.  
b. Capsize the kayak in the direction of the victim as you leave the kayak to rescue the victim (P-11K).



**P-11K**

- d. Victim is brought to front section of kayak using non-equipment rescue techniques (P-12K).



**P-12K**

- d. Rescuer climbs on top of kayak while holding the victim's arms (P-13K).

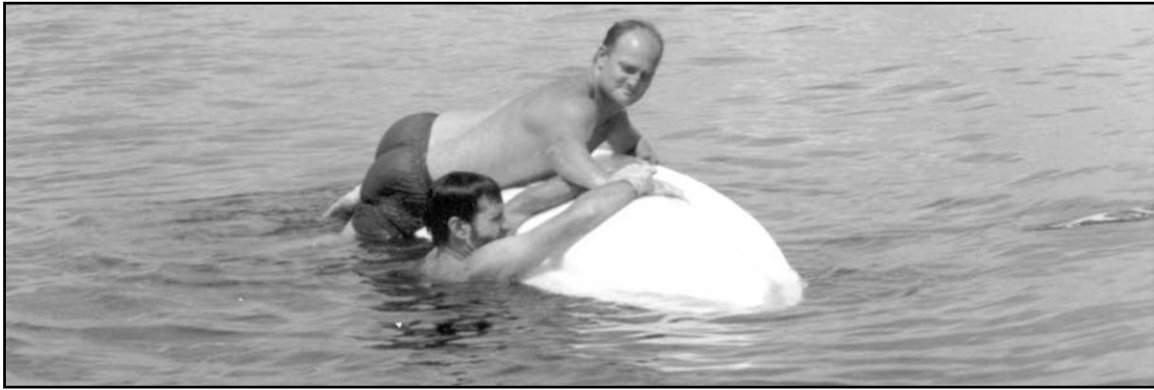

**P-13K**

- e. Place victim's arms halfway across the bottom of the kayak about 24 inches from the bow (P-14K) and roll kayak away from victim to its upright position (P-15K).

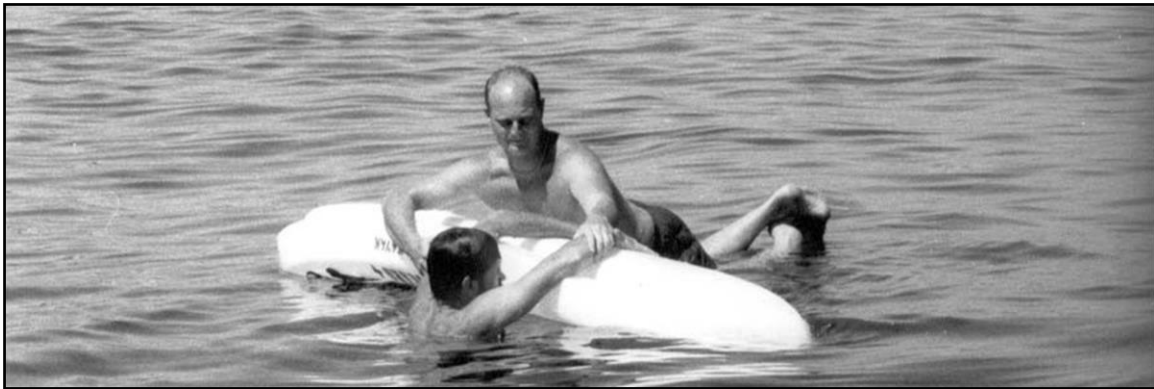

**P-14K**



**P-15K**



- f. The rescuer places one of his/her arms on the opposite side of the kayak for stability then climbs into the kayak (P-16K).



**P-16K**

- g. Rescuer straddles kayak and swings victim's legs into kayak (P-17K).



**P-17K**

- h. Check for breathing, give appropriate signals to shore, and paddle victim to shore (P-18K).



**P-18K**

### 3. Multiple Victims

Rescues when more than one victim are in close proximity. Below are some common procedures for multiple victims, however, multiple victim rescues are not always textbook cases and judgment is required.

- a. A lifeguard will approach the most distressed victim first. The lifeguard will then approach and assist the other victim(s) with the previously assisted victim(s) still hanging onto the kayak for support. In some situations, it is faster for the rescuer to enter the water and bring additional victims to the kayak rather than bringing the already burdened kayak to the additional victims. **Judgment is required!**
- b. Two conscious victims may be brought aboard kayak (P-19K) (P-20K) or they hang from the bow and stem of the kayak (P-21K). Rescuer paddles from normal paddling position.



**P-19K**



**P-20K**



**P-21K**

- c. With more than two conscious victims, victims should hang onto the sides of the kayak so the kayak is balanced.
- d. An alternative method with multiple victims is to put all the victims and rescuer on the ocean side of the kayak with the kayak parallel to shore. The victims and rescuer kick to get to shore or are towed by a line buoy. This alternative method eliminates the possibility of pearling.
- e. A multiple victim rescue when one victim is in serious condition. Give the tired victims a rescue buoy while getting the most distressed victim into the kayak (P-22K). The most distressed victim will be brought to shore in the kayak while other lifeguards tend to the additional victims.



- f. When there is a multiple victim rescue, additional lifeguards with a line buoy and other equipment should respond.
- g. If the kayak is not too overburdened and ocean conditions permit, the rescuer should paddle to meet the line buoy or paddle all the way to the shore.

#### H. Returning to Shore with the Victim

1. Keep the kayak perpendicular to the waves at all times.
2. Paddle to shore or call for the line buoy and get towed to shore.
3. Attach line buoy to bow line and signal for tow to shore when using line buoy for return.
4. When paddling or being towed, come in behind the last wave of a set or through a hole so there is a minimum of wave action.
5. In a wave keep your weight back so kayak does not pearl.
6. Inform victim when a wave is approaching and instruct victim to hold on.
7. Rescuer should hold onto victim as a wave passes.
8. Get out of kayak when you can stand and assist victim to shore.

## V. RESCUE BOARDS

The present rescue board is between 10'6 and 12 feet long, It travels faster than a swimmer and will support several victims.

### A. Regulations

1. Rescue boards not in use, should be kept next to lifeguard stands or directly behind the lifeguard stands.
2. Rescue boards should be distributed evenly on the beach.
3. Rescue boards should always be carried, not dragged.
4. Rescue boards should not be used in any way that may create a hazard to any person. Care must be taken not to run into or over any person with board because an injury may occur.
5. Upon closing each evening, rescue boards are to be carried to the designated storage area and properly stowed.

### B. Use of the Rescue Board

1. When to use:
  - a. For deep water patrol.
  - b. On rescues where long distances must be covered in the water.
  - c. Rescues with multiple victims.
  - d. On rescues where large amounts of debris or weeds are present.
  - e. In assisting capsized or disabled boats provided the bathing area is sufficiently protected.
2. When inadvisable to use:
  - a. Within crowded areas.
  - b. On rescues that would require the board to be carried long distances.
  - c. On rescues within the surf line.
  - d. On rescues where large surf is present.
  - e. When lifeguard is not proficient for conditions, a torpedo buoy is recommended for rescue.

### C. Getting to the Victim in the Ocean

To the extent possible the rescuer shall maintain visual contact with the victim.

1. Entering the ocean with the rescue board.
  - a. Hold the surfboard by the handles. Run down the beach while controlling the board in wind and avoiding patrons (P-1).



**P-1**

- b. Approach the shore break in a running crouch. Throw your shoulder and side into the wave and drive through with your legs while controlling the board with its handles. Be sure to keep the board perpendicular to the oncoming waves. Use your momentum (body weight and your velocity) in moving through the shore break or wait for a lull (P-2).



**P-2**

2. Paddling to the Victim

- a. When the water becomes deep enough the guard mounts the board and adjusts his/her weight so the board is balanced, and the nose of the board is 1/2" to 1" above the surface of the water. Always keep the rescue board perpendicular to the oncoming waves.
- b. The guard may paddle the rescue board in the prone position or kneeling. When paddling in the prone position an alternate arm stroke is used. When paddling in a kneeling position a simultaneous arm stroke is used (P-3), (P-4).



**P-3**



**P-4**

- c. To make small change in directions shift weight or drag a hand on the side, you wish to turn. To completely turn the board around move to the rear of the board, sit up and use hands and legs to achieve desired direction.

3. Paddling through the Waves: When taking a rescue board through white water and waves always keep the board perpendicular to wave and use one of the following methods:

- a. "Push-ups"-as wave hits board push up to allow water to pass between your body and board (P-5).



**P-5**

- b. “Turtle”-roll board over right before a wave hits. you are now under the board and underwater holding on to the handles while your legs cling to the board. Right the board and proceed when wave has passed.
- c. Go to the front of the board and dive under wave.

D. Making the Rescue

1. Tired Swimmer Rescue

- a. The rescuer makes the approach so that the victim is either on the left or right side of the board (P-6).

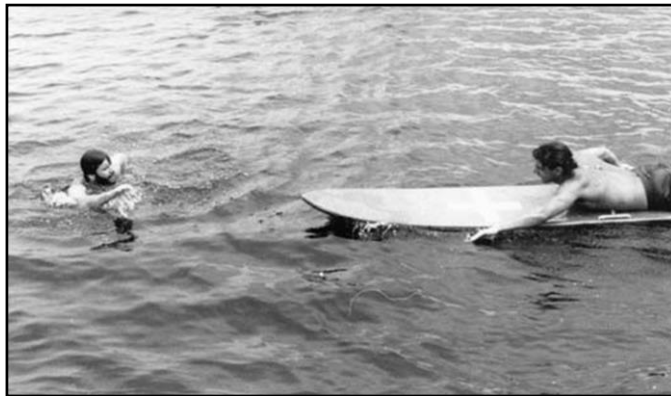

**P-6**

- b. The victim grabs the board and the rescuer slides his or her legs off the board away from the victim so that the board is lying across the middle of the board facing the victim (P-7).



**P-7**

- c. The rescuer now grabs the victim by the arms and pulls the victim onto the board while sliding backwards off the other side (P-8).





**P-8**

- d. The rescuer swings the victim's legs onto the board (P-9).



**P-9**

- e. The rescuer then gets on the board behind the victim and paddles to shore (P-10), (P-11).



**P-10**



**P-11**

2. Unconscious Victim

- a. The rescuer makes the approach so that the victim is either on the left or right side of the board (P-12).



**P-12**



- b. The rescuer slides off the board opposite victim, capsizing the board at the same time (P-13). The board is now upside down between the rescuer and the victim. The rescuer should reach across the board and grab the victim's arms (P-14).



**P-13**



**P-14**

- c. The victim's arms are placed across the board (P-15) and the board is rolled toward the rescuer to its upright position (P-16) thereby rolling the victim across and onto the board.



**P-15**



**P-16**

- d. The rescuer mounts the board, rotates the victim (P-17) (still in prone position) so that the victim's head is toward the front and paddles to shore (P-18). Give appropriate signals to shore and paddle victim to shore.



**P-17**



**P-18**

### 3. Multiple Victim Rescues

Rescue board rescues when more than one victim are in close proximity.

- a. A lifeguard will approach and assist the victim in the most trouble first. The lifeguard will then approach and assist the other victims with previously assisted victims still using the rescue board for support. In some situations it is quicker to bring additional victims to the rescue board using non-equipment rescue techniques (Chapter 9 American Red Cross Lifeguarding Textbook) than bringing a burdened rescue board to the other victims. Your judgment is required in effecting multiple rescues.
- b. Conscious victims in a multiple rescue can hang on to the side of the rescue board.
- c. Unconscious victims in a multiple rescue must be put on top of the board or held on the side of the board by a lifeguard.
- d. When there is a multiple victim rescue additional lifeguards and equipment should respond including a line buoy.
- e. To proceed to shore the lifeguard can best control a rescue board with multiple victims from the rear. Conscious victims may help propel the rescue board to shore or the lifeguard may signal for a line and get pulled to shore.
- f. When using the line buoy to be pulled to shore the line buoy guard must first clip the line buoy to rear of rescue board and then signal to be pulled in. When this procedure is used the rescue board comes in backwards.

### E. Returning to Shore with the Victim

1. Keep board perpendicular to waves at all times and paddle to shore or call for line.
2. Keep victim's weight and your weight back on the rescue board so, it does not pearl.
3. Inform victim when a wave is approaching.
4. Hold on to victim and board as a wave hits.
5. It is better to miss a wave than endanger victim trying to catch a wave.
6. Dismount board when you can stand and assist victim to shore.
7. Alternate method for returning multiple conscious victims to shore:

- a. Keep board parallel to shore.
  - b. Keep victims on seaward side of board. (A large amount of weight on the seaward side will prevent it from capsizing).
  - c. Victims and guards will kick in or be pulled in by line.
8. Be Careful!

F. Care of the Rescue Board

- 1. The rescue board should be checked daily for any cracks or holes in the fiberglass. Water will seep through cracks and ruin the board.
- 2. Upon finding damage to a rescue board it should be repaired or replaced immediately.
- 3. Always keep a coating of surfboard wax or paraffin on the top side of the rescue board.
- 4. Avoid injuries and damage to the board by placing it in a secure position so that it will not fall.

VI. SURF BOATS

The present fiberglass surf lifeboat is 17 feet in length, and about 350-pounds in weight. The surfboat travels faster in the water than a swimmer, especially over long distances. It is highly effective in making long distance rescues involving more than one victim. The surfboat is also used for patrol work and controlling bathers.

A. Location of Surf Boats

Surfboats are to be kept on the beach adjacent to designated lifeguard stands with a buoy (or other throwable device), oars and roller to allow for quick utilization.

B. Use of Surf Boats

- 1. When to Use
  - a. In surf rescues, when the time gained by speed of the surfboat over the swimmer or kayak offsets the time required to launch the surfboat through the surf and patrons.
  - b. For patrol outside the surf line.
  - c. On rescues involving capsized boats or rafts.

- d. On rescues requiring the guard to pass over heavy seaweed or debris.
- e. On rescues of long distance.
- f. On rescues involving multiple victims.
- g. On rescues where large amounts of debris are present.

2. When Inadvisable to Use

- a. On rescues within the surf line.
- b. On rescues involving large surf, the surfboat becomes a hazard to both guard and victim.



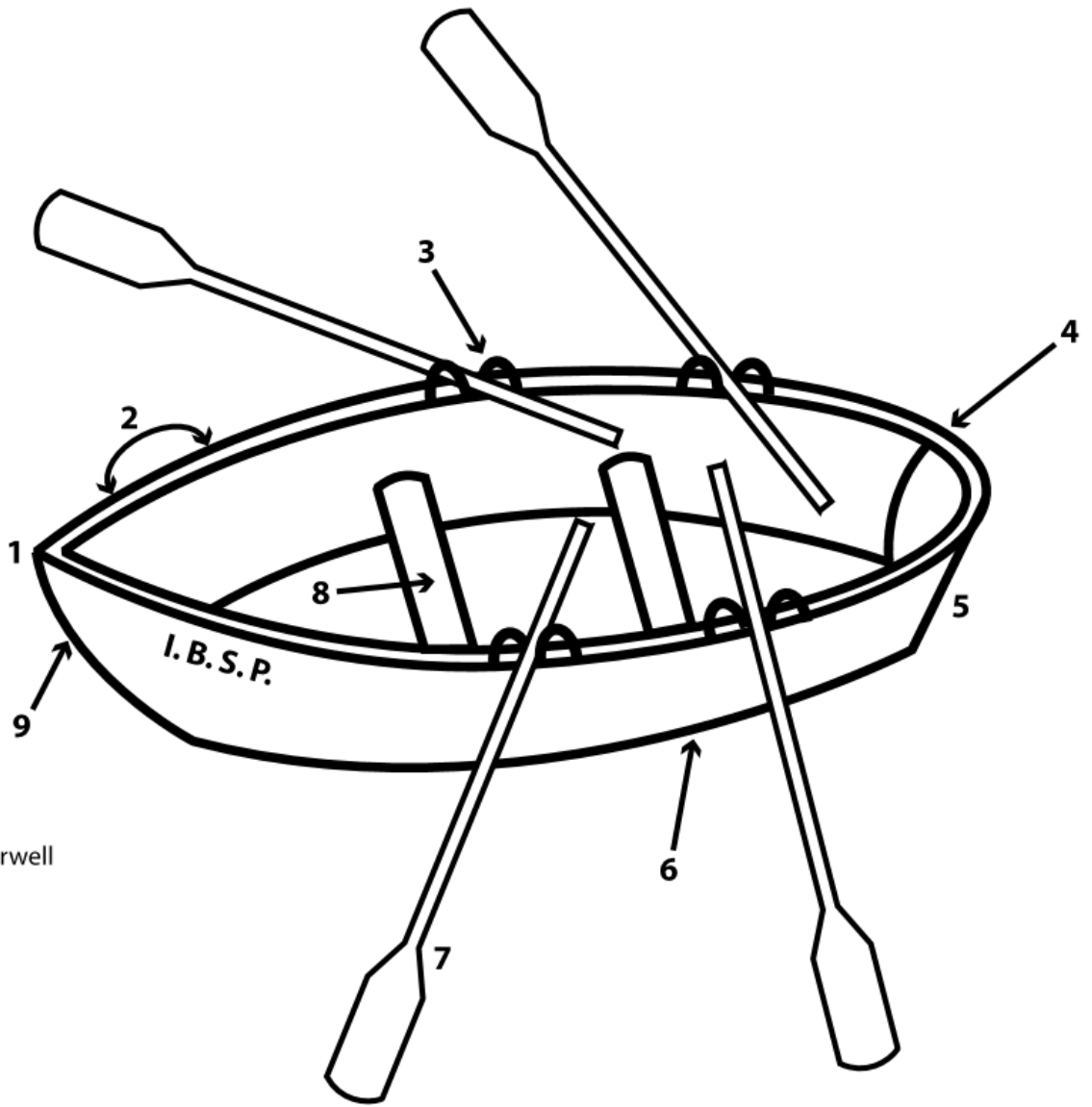

1. Bow
2. Gunwale
3. Oarlock and Oarwell
4. Stern
5. Transom
6. Chine
7. Oars
8. Thwarts
9. Stem

C. Some Things to Consider when Rowing:

1. If bringing any gear, personnel or victim ashore in the boat, come ashore stern first.
2. Always row with your back and legs. Just use your arms to hold the oars in place and follow through with your recovery.
3. Never let the boat get broadside in the surf line. Stay perpendicular to the waves.
4. If you capsize, stay with the boat on the ocean side.
5. Do not dip your oars too deep when you start to pull. Only the blade of the oar should be under water.
6. Feather your blades, close to the surface of the water on your recovery.
7. Always pay attention to the oncoming surf.
8. Caution should be used so patrons or lifeguards are not endangered.
9. Guards should be proficient in getting oars in and out of the oarlocks quickly.

D. Making a Surf Boat Rescue

1. Getting the boat into the water:

- a. All patrons should be cleared of area where boat is being launched.
- b. The boat should be pulled into the water by two lifeguards from the gunwales just forward of the bow oarlocks. When there is enough water under the boat to float the bow half, one of the lifeguards should enter the boat and assume a rowing position in the bow seat. The oars should be set in the oarlocks in a ready position, with the handles down and the blades elevated. The bow rower should not stroke until the boat is fully afloat.

2. Taking the Surf Boat through the surf:

When the first lifeguard enters the boat and takes the position in the bow seat, the second lifeguard should go to the stern of the boat. The second lifeguard keeps the bow of the boat pointing directly into the oncoming wave set. The boat should be pushed out by the second lifeguard (stern rower) at the first lull in the wave set. If large waves are encountered on the launch, the stern rower should push down on the transom allowing the bow to rise and meet the oncoming surf. When the stern rower has pushed the surfboat out to approximately waist depth, the stern rower should enter the boat from over the transom and commence rowing immediately. The bow rower shall pick up the stern rower's stroke. The bowman shall maintain the proper direction while the stern man sets the rowing pace. Always keep the boat perpendicular to the waves.

3. Making the Rescue

- a. The victim is in need of an assist.
  1. While paying attention to the wind and surf approach the victim, from the stern, and throw a buoy to the victim.
  2. If it is a very short distance to where the victim can stand safely, tow victim on buoy.
- b. The victim is weak, there is a long distance to safety or surf conditions exist that require the victim to be brought aboard.
  1. A conscious victim should be thrown a buoy and pulled to the boat (P-16).
  2. An unconscious victim must be brought to the boat by a guard.
- c. After the victim is brought to the boat, one lifeguard will secure the victim's hands to the gunwales just to the rear of the front oarlocks (P-17). Both lifeguards will lean to the side of the boat to make it easy for the victim to grab the gunwales.
- d. One lifeguard will then pull the victim into the boat (P-18) while both life- guards lean to one side.
- e. While the victim is in the boat, have victim sit in the stern. Rowers will now proceed to shore. Victim will not leave the boat until the boat is ashore.



**P-16**



**P-17**



**P-18**

4. Bringing the Boat to Shore

- a. Signal stand lifeguards that boat is coming ashore.
- b. The boat should be kept perpendicular to the waves.
- c. The lifeguards should try to row back to the beach through a hole, or behind the last wave of a set so there is little wave action.

- d. Before beaching the boat, it should be turned so the bow faces seaward. This allows the rower to row into a wave if necessary. When waves are not present, the boat is back oared to shore until lifeguards from stands take control of the stern as if the boat was being launched and guide the boat to shore.
- e. All patrons must be moved out of the way by stand lifeguards before boat is brought to shore.
- f. If a boat is parallel to a wave or goes parallel when hit by a wave, the boat has broached. The lifeguards should transfer their weight to the seaward side to prevent the boat from flipping over (capsize).
- g. If a boat goes out of control when hit by a wave coming to shore, a lifeguard should try to hang off the back of the transom to slow it down (sea anchor).

## VI. TORPEDO BUOYS (TORPS, RESCUE BUOY, CAN)

Torpedo buoys are 34 inches long and have a sling to tow the buoy while swimming. They are designed to support more than one victim if necessary, and they are used on all swimming rescues. When used without a line, it is referred to as the free buoy.

### A. Regulations:

- 1. Each torpedo buoy will be checked the beginning and end of each day for damage. Damage will be reported immediately through the chain-of-command.
- 2. Torpedo buoys should never be used as anything but flotation devices.
- 3. Unauthorized persons for any reason should never use torpedo buoys.
- 4. Torpedo buoys on a stand must have the sling easily accessible.
- 5. Guards will carry torpedo buoys while on patrol off the lifeguard stand.

### B. Use of the Torpedo Buoy

- 1. When to use:
  - a. For rescues in the bathing area
  - b. On multiple victim rescues
  - c. For long distance rescues when a PWC, kayak/rescue board or boat is not available or practical.
- 2. When inadvisable to use:
  - a. For rescues where a long water distance must be covered, when a kayak/ rescue board, personal watercraft or surfboat are available. If



other equipment is not available, you must swim and take a torpedo buoy.

- b. For rescues where pollution, hazardous materials/marine life or dense seaweed are present.

C. Torpedo Buoy Rescues:

1. When a lifeguard observes a potential rescue, they should stand up. (P19). This is to alert the other lifeguards to a potential rescue.
2. When the rescuer is going out for a rescue, they put on the torpedo buoy sling and holds the torpedo buoy while running through the shallow water (P20). When the water becomes too deep for running, he drops the torpedo buoy to his side. This procedure will keep him from getting entangled in the torpedo rope (P21). When the water is too deep to run, the rescuer dolphins until swimming becomes faster.
3. Dive under waves encountered in the surf zone and grab the bottom on very large waves (P22).

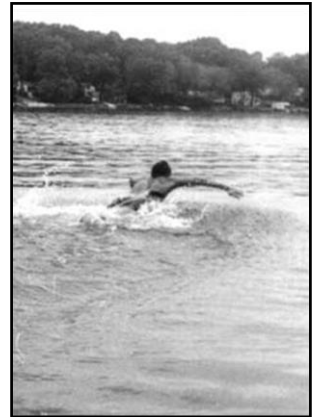

- a. The rescuer stops just out of reach of the victim and puts the torpedo buoy between his/herself and the victim (P23).
- b. When the victim grabs the buoy, the rescuer can proceed to shore by towing the victim (P24) or signaling for a line buoy if one is not already on the way.
- c. If the victim is weak, the guard goes behind the victim and secures the victim on buoy before returning to shore (P25).
- d. It is important to talk to the victim during this process. Explain what you are doing and assure them that everything will be fine.
- e. Tell a victim when a wave is coming so they can hold their breath.



**P-23**



**P-24**



**P-25**

4. Unconscious Victim

- a. Place the victim's arms on top of the torpedo with the victim's back to the rescuer (P26). The guard then puts his arm under the victim's armpit and holds the buoy against the victim's chest (P27). Check breathing and signal to shore as appropriate. (Ref. USLA Manual)
- b. Proceed to the shore by swimming or call for the line buoy if it is not on its way.
- c. Get an unconscious victim to shore the fastest way possible. Make sure that the victim's face is out of the water. Cover the victim's mouth and nose when a wave passes over.



**P-26**



**P-27**

Multiple Victim Rescues- Torpedo buoy rescues when more than one victim is in close proximity.

- a. A lifeguard will approach and assist the victim in the most trouble first. Additional victims may be assisted by bringing the buoy to the victim or bringing the victim to the buoy using non-equipment rescue techniques. Your judgment is necessary with multiple victims because every situation is different.
- b. Conscious victims may hang on to the buoy in a multiple rescue.

- c. Unconscious victims must be held onto the buoy by a lifeguard.
- d. When all victims are secure, the lifeguard and victims may proceed to shore by swimming or signal for a line buoy.
- e. When there is a multiple victim rescue, other lifeguards with equipment should assist. The additional equipment should include a line buoy.

## VIII. LINE BUOY

The line buoy combines the torpedo buoy with a 200-yard line. This combination enables quick return of victims in rough water or strong rips. The line allows guards on shore to pull in the buoy. This is usually quicker than a guard towing a victim to shore. The 200 yards of rope is kept in a line box.

### A. Regulations

1. Each line buoy and line box will be checked at the beginning and end of each day for damage or a fouled line. Damage will be reported immediately through the chain-of-command.
2. Line buoy and line box should never be used as anything but floatation/tow-in devices.
3. The line buoy on a stand must have the sling easily accessible.

### B. Use of the Line Buoy:

1. When to use:
  - a. For rescues in the bathing area when it is difficult to return to the beach.
  - b. On multiple victim rescues.
  - c. For deep-water rescues when a kayak/rescue board, personal watercraft or boat is not available or practical.
  - d. When a rescue is in progress and a line is requested.

2. When inadvisable to use:

For rescues where a long distance must be covered when a kayak/rescue board, personal watercraft or boat are available. If other equipment is not available, a lifeguard must swim and take a free buoy followed by a second lifeguard with a line buoy. It generally takes longer to get to a victim with a line buoy than a free buoy. This is why a free buoy always goes first on a rescue.

## IX. BACKBOARDS AND CERVICAL COLLARS

### A. Backboards and Cervical Collar Use:

1. Backboards can be used as a stretcher whenever a victim must be moved from the water or the beach.
2. A backboard must be used whenever there is a victim with a suspected neck or back injury in the water. If the victim with the suspected neck or back injury is on land, the lifeguard should assess the extent of the injury. If the victim is in no immediate danger of further injury, the victim should not be moved until rescue squad personnel arrive and administer to the victim.
3. If the victim complaining of spinal injury symptoms is standing, you may consider a standing backboard or hold in line stabilization until the rescue squad or paramedics arrive.
4. Cervical collars and head immobilizers are to be used in conjunction with the backboard to immobilize the neck in any injury where there is a suspected back or neck injury.

### B. Suspect neck and back injuries if:

1. The victim is unable to move either arms or legs after the accident (most cases).
2. The victim has severe pain and spasms of the neck muscles.
3. The victim has difficulty in moving his/her head.
4. The victim complains of numbness or the loss of feeling.
5. The victim has experienced trauma (diving, shore break, etc.).

**NOTE:** Neck and back injuries resulting from water accidents require special first aid measures because cervical spine (neck and back) fractures are complicated by the possibility of drowning.

Cervical spine injuries are more likely to cause paralysis than any other type of injury. Therefore, it is imperative that the lifeguard takes extreme care when tending to a victim with this kind of injury.

When neck or back injuries are suspected, the first lifeguard reaching the victim will alert the other guards using the proper hand signal, to request a backboard and cervical collar. The victim who has a suspected neck or back injury should not be moved from the water without an effort to maintain in-line stabilization (immobilization).

In-line stabilization is defined as alignment of head and neck with the body while

keeping movement of the spine to a minimum.

Removal of a victim with a spinal injury from the ocean due to varying surf, temperature, tide, and bottom is difficult at best. The procedures used must be adapted to the conditions.

In this section, methods of dealing with spinal injuries in various situations will be discussed. You must learn these skills and use your judgment as when to apply skills. In some conditions, there may be no perfect method and you must do what you believe is best to prevent further harm to the victim.

If artificial resuscitation or CPR is necessary when a spinal injury is suspected, the victim must be moved to shore as quickly as possible and the modified jaw thrust method is used to open the airway.

C. Removal of the victim from deep water with a suspected Spinal injury.

1. If the victim is face up, the first rescuer will approach the victim from the side facing the victim while carefully moving the victim's arms parallel to the side of the victim's head. The rescuer's right hand secures the victim's right arm and left hand secures the left arm. The rescuer will grasp the victim's arm between the shoulder and elbow. The victim's arm must then be held securely against the victim's head at about the ears. The rescuer's hand holding the victim's far arm will be under the victim's head (Fig.-1). This method of immobilization is referred to as the head splint method.

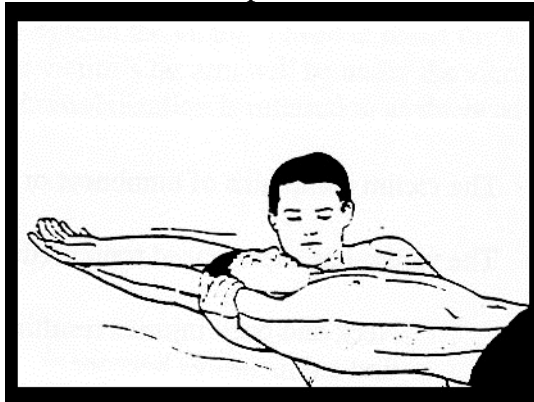
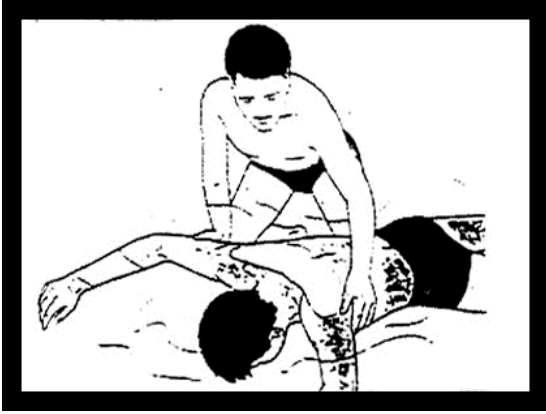
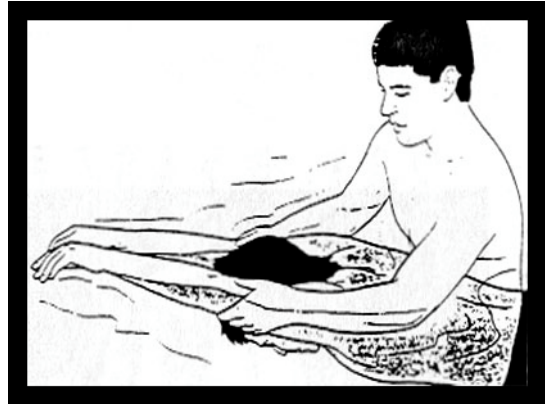

FIG-1

2. If the victim is face down, the rescuer will approach the victim from the side. The rescuer will move the victim's arms carefully to the side of the victim's head (Fig.-2). The rescuer's right hand will grasp the victim's right arm between the elbow and shoulder while doing the same with the left hand and left arm. The victim's arms are held securely against the victim's head to maintain in-line stabilization of the neck and body (Fig.-3). To rotate the victim to a face-up position, push the victims near arm under water while pulling the victim's far arm toward you (Fig.-4). The rescuer now has one arm under the victim's head grasping the far arm with the other hand holding the near arm. Maintaining pressure on both the victim's arms against his/her head allows for in-line stabilization of the head and neck (Fig.-5).



**FIG-2**



**FIG-3**

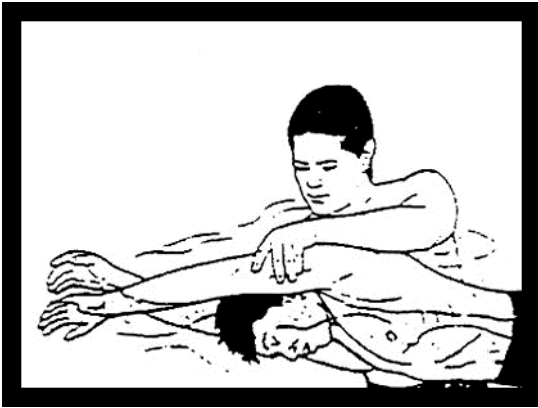

**FIG-4**



**FIG-5**

3. If additional support of the back is needed, the lifeguard can maintain pressure on the victims near arm with his/her chest while supporting the victim's back with his/her free arm. Holding a rescue buoy with the arm supporting the lower back or hips is an option for more buoyancy (P-1).
4. The single rescuer should now make his/her way to shore or to a location where it is safe to await assistance while maintaining head splint with victim's head toward incoming surf.
5. When a second rescuer arrives, this person will support the hips and legs while holding the rescue buoy similar to (P-1) if additional buoyancy is needed (P-2)



**P-1**



**P-2**

6. At this point, a decision is made based on conditions to:
  - a. Remain at this location and wait for a backboard.
  - b. Move the victim to a safer location and await backboard.
  - c. Bring the victim to shore before attempting to backboard the victim.
7. If a decision is made to remain at the present location, when the backboard arrives the rescuer applying the head splint will carefully move to a position above the head maintaining head splint, so the backboard can be placed under the victim (P-3). The victim is now moved to shore where the victim is secured to the backboard as described in section F (P-4).



**P-3**



**P-4**

8.
  - a. If a decision is made to move to a safer location or shore, the guard applying the head splint will carefully move from the side of the victim to a position above the head maintaining the head splint. The victim will now be moved feet first to a safer location. The head splint rescuer's back is to the waves to shield the victim from wave action (P-5). Rescuers will remain in this safer location until other guards arrive with a backboard.
  - b. When the backboard arrives, the guard applying the head splint will maintain the head splint from a position above the victim while the backboard is positioned under the victim (P-3). While maintaining the head splint move the victim to shore (P-4) where the victim is secured to the backboard as described in section F.
9.
  - a. If a decision is made to move the victim to shore without a backboard, the guard supporting the head will carefully move from the side of the victim to a position above the victim maintaining in-line stabilization with the head splint method. The victim will now be moved feet first to shore. The guard using the head splint method will have his/her back to oncoming waves to shield the victim (P-5).

- b. As the victim gets closer to shore, additional guards will help carry the victim to shore to await the backboard (P-6).



**P-5**



**P-6**

- c. If three guards are not available, the guard applying the head splint will move back to the victim's side using his/her chest and one arm to maintain the victim's arms against the head. The rescuer's other arm is now free to lift and support the victim's back as the second rescuer supports the victim's mid-section (P-7).



- d. The victim will be placed on the beach or backboard while maintaining in-line stabilization. The victim will be secured to the backboard as described in section F.



**P-7**

**NOTE:** The victim's airway, breathing and pulse should be assessed as soon as possible after immobilization is accomplished in water. Swim fins may be helpful in deep water.

- D. Neck or back injury is suspected in extremely shallow water with the victim face up.
1. The first rescuer will apply the head splint method from above the victim to maintain in-line stabilization. If there is wave action or shore break in this area, the guard will attempt to move the victim as far up the beach as possible with the help of the water while keeping the victim's head and neck as low to the beach as possible to avoid further injury (P-8). Apply cervical collar and backboard as described in section G.



**P-8**

2.
  - a. If a second guard is present, he will support the victim's hips as the victim is moved up the beach (P-9).
  - b. If the victim is light enough, the shore break is severe and enough guards are available, it may be best just to carry the victim out of danger.
  - c. If the victim is carried out with just two guards, the guard applying the head splint method will do so from the side maintaining alignment with the rescuer's chest and far hand holding the victim's arm and head in place, while the free arm supports the victim's shoulders. The second rescuer supports the victim's lower back and hips as the victim is brought to shore and lowered onto beach or backboard. Apply cervical collar and backboard as described in section G.



**P-9**

3. If there is no dangerous wave action, apply head splint from above and await backboard. Apply cervical collar and backboard as described in section G.
- E. Victim is face down in shallow water with a suspected neck or back injury. The victim must be turned over to allow breathing while care is taken to maintain in-line stabilization.
1. Only one lifeguard is immediately available. This lifeguard will apply the head splint technique from above the victim's head (P-10). The rescuer will roll the victim face up. One of the rescuer's arms will be under the victim's head (P-11). This arm can carefully be moved to a more comfortable position from under the victim's head while maintaining in-line stabilization. If there is no wave action, await backboard. Apply cervical collar and backboard as in section G.



**P-10**



**P-11**

2. If wave action or shore break threatens the victim, the lone rescuer can drag the victim up beach when there is water while maintaining head splint as low to the beach as possible (P-8). Cervical collar and backboard are then secured as described in section G. It is best to wait for a second rescuer if possible.
3. If two rescuers are available, one rescuer applies the head splint and the second rescuer positions his/her hands at the victim's shoulders and hips (P-12). The victim is now rolled to a face up position (P-13). Again, the rescuer applying the head splint must carefully realign his/her hands to a comfortable position. If there is no wave action, await cervical collar and backboard and apply as described in section G.

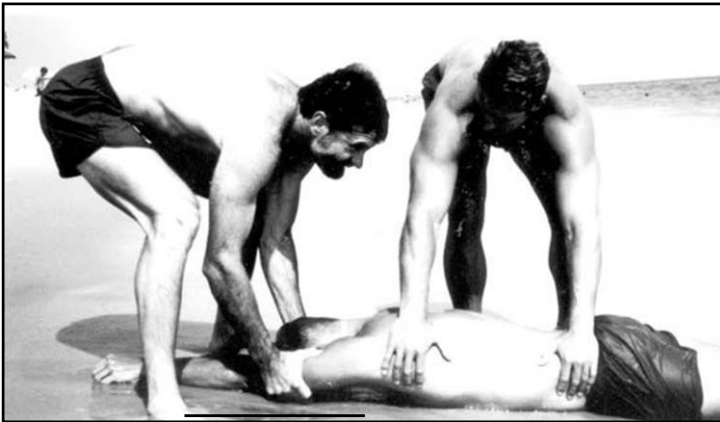

**P-12**



**P-13**

4.
  - a. If wave action threatens the victim, the victim may be dragged up the beach with one guard applying head splint and the other guard supporting the hips (P-9).
  - b. If the victim is light, two guards may be able to carry the victim from danger, with guard applying head splint on the side of the victim using one arm to support the shoulders as the other guard supports the mid-section of the victim (P-7). With the victim now on the beach, a backboard is secured as described in section G.
5. If it is a heavy victim who must be moved quickly out of wave action, as many guards as possible should be used to carry victim from surf while maintaining in-line stabilization. Cervical collar and backboard are secured as in section G.

**NOTE:** As in deep water, airway breathing, and pulse should be evaluated as soon as possible.

F. Securing the victim to a backboard that has been placed under the victim in the water. The victim is moved to the beach on the backboard while utilizing the head splint.

1. Another rescuer takes over the head splint while the rescuer originally applying the head splint grasps the victim's head to maintain alignment (P-14 & P-15).



**P-14**



**P-15**

2. While the head is held in alignment, the head splint is released. The guard releasing the head splint moves the victim's arms to his/her side (P-16).
3. The cervical collar is then applied to the victim as described on the following page of diagrams (P-17).



**P-16**



**P-17**

# STIFNECK

Original Stifneck Extrication Collar  
Original Select and Pedi-Select Extrication Collar

ENGLISH

## 1 Measure the patient

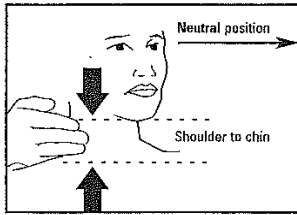

Align the head to neutral or "eyes forward" position unless contraindicated by your protocol.

## 2 Match the collar size to the patient

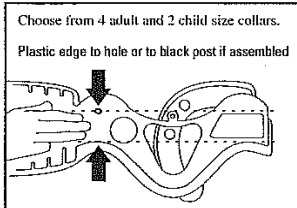

Choose from 4 adult and 2 child size collars.  
Plastic edge to hole or to black post if assembled

**Stifneck Original Collar**

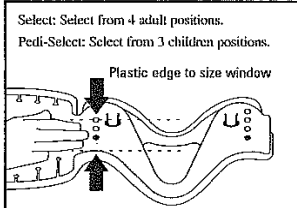

Select: Select from 4 adult positions.  
Pedi-Select: Select from 3 children positions.  
Plastic edge to size window

**Select/Pedi-Select Adjustable Collar**

Same basic method of adjusting for both Collars.

## 3 Assemble the original collar

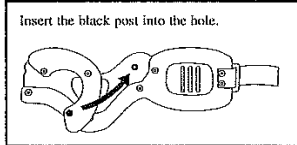

Insert the black post into the hole.

**Stifneck Original Collar**

## or Adjust and Lock the adjustable collar

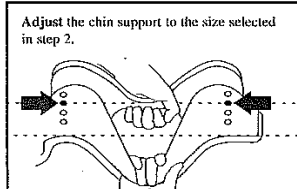

Adjust the chin support to the size selected in step 2.

**Select/Pedi-Select Adjustable Collar**

Same sizing method for Select and Pedi-Select

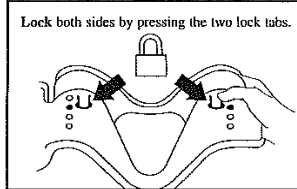

Lock both sides by pressing the two lock tabs.

## 4 Preform the collar

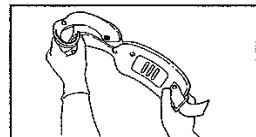

## 5 Apply the collar while manually maintaining neutral head position

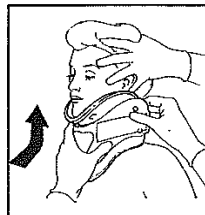

Place the chin support well under the chin. If a different size is needed, remove, re-size, and re-apply the collar.



Pull the back of the collar snug while holding the front in place, then fasten.

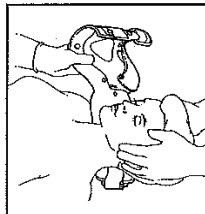

For a supine patient, slide the rear panel behind the neck before placing the chin support.

**Important:** Do not adjust the Select/Pedi-Select collar on patient.

**Storage:** Do not store collar in folded position. Store flat.

### IMPORTANT

Warning: To insure proper use, please review all material in this OFU.

All Stifneck products should only be used by persons who have received adequate training. In cases of suspected spinal injury, proper cervical immobilization is only one part of an immobilization system.

It is important that the patient be properly immobilized to prevent movement of the spine (per local protocol).

Do not use an improperly sized collar. Too large a collar may hyperextend a patient's cervical spine; too small a collar may not provide appropriate stability. Special sizes of Stifneck collars are available for children and others with small bodies.

### WARRANTY

Please see the Global Warranty statement for terms and conditions.

[www.laerdal.com](http://www.laerdal.com)

Storage Temperature Range:

-34°C to 52°C (-30°F to 125°F)

Operating Temperature Range:

-18°C to 43°C (0°F to 110°F)



The product is in compliance with the essential requirements of Council Directive 93/42/EEC Medical Devices Directive.

4. Victim is secured to the backboard with straps starting at the chest and working down to the feet (P-18).
5. The head immobilizer blocks are now placed next to the victim's head one at a time. The guard maintaining head alignment moves one hand as the first block is secured and then removes his/her second hand to allow the second block to be secured (P-19). The guard holding the head alignment now supports the blocks with both hands until the head straps are secured.



**P-18**



**P-19**

6. Attach straps to the head immobilizer. One strap is secured over forehead using appropriate rings on immobilizer base. The second strap is secured over the chin or cervical collar (P-20).
7. The victim is now secure and ready for transport (P-21).



**P-20**



**P-21**

**NOTE:** Wool blankets should be used to keep victim warm.

- G. Positioning and securing the victim to the backboard if the victim is on the beach or in extremely shallow water with the head splint method being utilized for alignment.

1. The head splint method is substituted for head alignment by a rescuer just holding the head. Another rescuer takes over the head splint from the opposite side as the original rescuer grabs the head to maintain alignment (P-22 & P-23).



**P-22**



**P-23**

2. While the head is held in alignment, the head splint is released. The guard releasing the head splint moves the victim's arms to his/her side (P-24).
3. A cervical collar is then applied as described on page 69 (P-25).



**P-24**



**P-25**

4. The second rescuer places the victim's arm above the head on the side the victim will be rolled for backboard placement. The second rescuer now grabs the victim's shoulder and hips and rolls the victim toward himself/herself. The backboard can then be positioned.



5. The victim is now lowered on the backboard to a supine position (P-26).
6. The straps are now applied to the victim from the chest to feet (P-27).



**P-26**



**P-27**

7. The head immobilizer blocks are now placed next to the victim's head. The guard maintaining the head alignment moves one hand as the first block is secured and then removes his/her second hand to allow the second block to be secured (P-28). The guard holding the head alignment now supports the blocks with both hands until the straps are secured.



**P-28**

8. Attach straps to the head immobilizer. One strap is secured over the forehead using appropriate rings on the immobilizer base. The second strap is secured over the chin or cervical collar (P-29).
9. The victim is now secure and ready for transport (P-30).



**P-29**



**P-30**

H. Standing Backboard – Victim is standing and complains of symptoms of a neck or back injury.

1. A guard will hold the head and neck in alignment while facing the victim. (P-1)
2. When the immobilization equipment arrives, a second guard will apply the correct size cervical collar as described in Section G. (P-2)

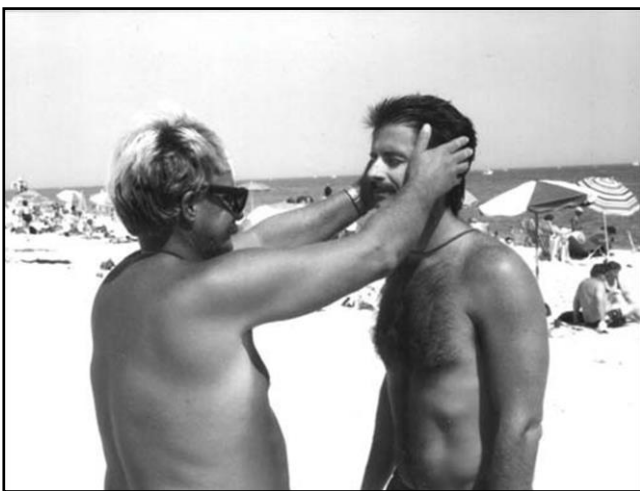

**P-1**



**P-2**

3. A guard will now place the backboard behind the victim. (P-3)
4. Two guards will now hold the head and neck in alignment while holding the backboard against the victim's back. One guard on each side of the victim will hold the backboard with his/her near arm through the victim's armpit, while the guard's other arm holds the victim's head in alignment. (P-4)



**P-3**



**P-4**



**P-5**

5. A third guard will go behind the victim and backboard. While holding the top of the backboard, this guard will lower the backboard to the ground while the other two guards hold the board while maintaining in-line stabilization. (P-5)

6. When the victim and board are on the ground, the two guards maintaining in-line stabilization will release the head as the third guard takes over the head alignment.
7. The victim is now secured to the backboard with straps from the chest to the feet followed by head immobilization. The victim is ready for transport.

#### X. POCKET MASKS AND BAG VALVE MASKS (BVM):

- A. Pocket masks and BVM are devices designed to fit over the mouth and nose of a victim that has stopped breathing. Masks are to be used while performing rescue breaths or CPR, to prevent transmission of communicable diseases when doing ventilations on a victim that has stopped breathing.
- B. All pocket masks and BVM will be used according to approved techniques taught by the American Red Cross.
  1. To review proper use of the pocket mask or BVM consult the American Red Cross CPR/AED for the Professional Rescuer textbook.
  2. Each rescuer who is giving ventilation should use his/her pocket mask.
- C. Regulations:
  1. At least one pocket mask shall be at each lifeguard stand.
  2. Every First Aid Room shall have at least one pocket mask, adult BVM and child BVM.
  3. When a pocket mask or BVM is discarded, it will be replaced as soon as possible.
- D. Care:
  1. Pocket masks, one-way valves and BVM used in training should be cleaned. Wash and scrub in warm soapy water. Rinse in clean water. Soak for 10 minutes in a 1:64 bleach water solution. Rinse again and allow to air dry.
  2. After a pocket mask or BVM is used on a victim, the mask, and valve should be discarded. Request replacement from ambulance.

#### XI. BEACH WHEELCHAIR

This is a chair designed to be used by persons with disabilities on the beach. It is not to be taken into the water. When not in use, the Beach Wheelchair may be useful in removing injured patrons from the beach.

- A. Use of the Beach Wheelchair
  1. The wheelchair is to be signed out, on a first come first-served basis, to be used to transport patrons.

2. The First Aid Room attendant handles Beach wheelchair sign out.
3. Lifeguards must be aware of the sign out process, who does it and other wheelchair regulations.
4. Users and attendants of Beach Wheelchairs must be advised of the following:
  - a. When going down a slope, attendant and wheelchair must go backwards.
  - b. How to apply the parking brake.
  - c. Weight limit is 300 pounds.
  - d. An attendant is required to move the Beach Wheelchair. If a person needs an attendant non-lifeguard personnel may be used.

B. Care of the Beach Wheelchair

1. Air pumps and needles like those used to inflate a basketball are needed to pump up the tires. The tire pressure is 3 pounds.
2. Report any damage (flat tires, etc.) to the Superintendent immediately so it can be fixed.

XII. PERSONAL WATERCRAFT (Jet Ski, Waverunners)

Personal watercraft (PWC) is a power craft operated by a lifeguard. PWC is used to respond to emergencies reported off beach, assist on rescues in the bathing area and patrol.

A. Location of PWC

One PWC will be located near 111 path. The PWC will remain near the waterline on trailer for efficient utilization (P-W1).



**PW-1**

B. Use of Personal Watercraft

1. A PWC may only be used by lifeguards who have completed both the prescribed training program and a State of New Jersey approved boating safety course. A life-guard must be at least a fourth-year guard or lifeguard officer to become a PWC operator.
2. A lifeguard officer will determine use of a PWC in the following situations.
  - a. Response to emergencies and problems reported outside the bathing area provided the bathing area is sufficiently protected.
  - b. Performing or assisting rescues in the bathing area.
  - c. Enforcement of area regulations.
3. When inadvisable to use:
  - a. On rescues within the surf line.
  - b. On rescues in a crowded area.
  - c. On rescues involving large surf.
  - b. White water.

C. Maintenance of Personal Watercraft

1. The PWC will have all systems checked and tuned up, before the season, at mid-season and as needed.
2. The PWC will be maintained on a daily basis according to requirements of PWC maintenance log.
3. A lifeguard officer will be assigned for daily maintenance of PWC. The officer is responsible for completion of the PWC maintenance log.
4. All mechanical problems or damage must be reported to the Superintendent immediately so PWC can be repaired.
5. Any damage or mechanical problems must be recorded on the Daily Lifeguard Report in addition to the PWC maintenance log.

PWC Equipment

1. First Aid Kit with Pocket Mask
2. Masks, Fins, Snorkel
3. Radio Bag
4. Tow Rope with Clip
5. Rescue Sled
6. PFD(s) with spare safety lanyards
7. Rescue Tube

8. Fire Extinguisher
9. Helmets for operator and rescuers
10. Compass
11. Knife

E. Launching PWC

1. Lifeguards must clear water and beach of patrons where PWC is launched.
2. Pre-start engine then stop engine to launch.
3. Push PWC into ocean pointing into waves at best possible time (lull). Do not start PWC until it is floating in ocean with operator in position (P-W2).



**PW-2**

4. Before the take off of a PWC, the operator will say “clear”. If it is safe, all launchers and rescuer will say clear, if it is not safe to do so respond “no”.
5. Operator will keep PWC perpendicular to waves until past the surf zone. F.

Landing PWC

1. Signal to lifeguards on appropriate stand that PWC will be landed.
2. Patrons will be cleared on the beach and in the water of the landing area.
3. Guards will prepare to land PWC in shallow water.
4. Operator will bring PWC into shore behind a wave (wave trough) perpendicular to the wave.

G. Safe Operation of PWC

1. Always use PWC with caution. Watch for patrons.
2. Never jump waves.

3. Do not operate PWC in surf zone when it is not necessary.
4. In the surf zone, keep PWC at a 45 to 90 degree angle to waves.
5. For safety and effectiveness, always be aware of wind, surf, water and all 360 degrees around you. Then adjust speed, trim and direction of the PWC.
6. Travel at a speed that is safe for the prevailing conditions. Slow speeds are required when going through waves and on rescues. **Remember slow is pro (PW-3)!**



**PW-3**

7. Operator must attach safety lanyard to his or her wrist.
- H. Making a PWC Rescue
1. Conscious Victim, One Lifeguard
    - a. Operator will instruct victim to raise one arm above his or her head.
    - b. Operator will approach victim face to face on the side of PWC, where the victim's arm is raised, at a time when it is safe to do so. PWC operator will decide when it is safe to approach the victim based on prevailing conditions.
    - c. The operator while slowly moving towards the victim will grab the victim's hand and using the momentum of the PWC will guide the victim onto the body board. Instruct the victim to hold onto the handles (PW-4 and PW-5). If this method does not work, you have to stop the PWC next to the victim and attempt to pull the victim onto the body board or use the rescue tube.
    - d. The victim will then be dropped off at a safe location.





**PW-4**



**PW-5**

2. Conscious victim, Two lifeguards (Operator and Rescuer).
  - a. Operator will instruct the victim to raise one arm above his or her head.
  - b. Operator will approach the victim on the side of the PWC, that the victim's arm is raised, at a time it is safe based on prevailing conditions.
  - c. The operator while slowly moving towards the victim will grab the victim's hand and hand the victim back to the rescuer. The rescuer who is on the body board will secure the victim to the body board (PW-6, PW-7).
  - d. If the above method does not work the operator and the rescuer will pull the victim onto the body board or the rescuer will get the victim with the rescue tube. The rescuer will then try to get the victim onto the body board with the assistance of the operator (PW-8 and PW-9).
  - e. Rescuer will then secure the victim's body to the body board. The operator will drop off the victim and the rescuer at a safe location (PW-10).



PW-6



PW-7



PW-8



PW-9



PW-10

3. Unconscious Victim- One Lifeguard
  - a. Lifeguard will get as close as safely possible to unconscious victim based on the conditions.

- b. Lifeguard will radio or signal for assistance then leave PWC with rescue tube.
  - c. Operator will attempt to pull victim onto PWC or body board, secure the victim and then return to shore.
  - d. If it is not possible to get the victim onto a body board, secure the victim with the rescue tube and wait for assistance or proceed to the shore without the PWC. **Good judgment is required to handle this situation!**
4. Unconscious Victim-Two Lifeguards (Operator-Rescuer)
- a. Operator will approach victim from the side of PWC at a time when it is safe to do so.
  - b. Rescuer and operator will pull the victim onto the body board. Rescuer will secure the victim and the operator will return to the shore.
  - c. If necessary, rescuer will leave PWC with rescue tube.
  - d. Rescuer will secure victim to rescue tube and bring victim to the body board.
  - e. Operator will assist placing victim on body board. The victim will then be pulled onto his or her back and onto a body board then rolled to a supine position. Refer to PW-9. (Victim will remain on back if rescue breathing or CPR needed).
  - f. Rescuer will secure victim to body board. Refer to PW-10.
  - g. Operator will bring PWC, rescuer and victim to safety.
  - h. Victim and rescuer will be dropped off as close to shore as possible.
  - i. Rescue breathing can be started if necessary and possible on the body board.

### XIII. ALL TERRAIN VEHICLE (ATV)



The all-terrain vehicle may be utilized to maintain beach safety, assist with lost and missing persons, maintain control over areas adjacent to designated bathing area and respond to off beach rescues.

A. Use of ATV

1. May only be used by lifeguards who have training in ATV safety and handling.
2. One or two lifeguards may use ATV.
3. A lifeguard may use ATV in an emergency or when directed to do so by a lifeguard officer.
4. A lifeguard operating the ATV must proceed with caution at a safe speed to any emergency or other assignment.
5. Driver and passenger must wear a helmet.
6. The ATV is not for personal use or joyriding.

B. Equipment

1. Torp/Rescue Tube
2. First Aid Kit
3. Mask, Fins, Snorkel
4. Radio
5. Helmets

C. Maintenance

1. A lifeguard officer will be responsible for maintenance.
2. The ATV will be tuned up and have all systems checked at the start of the season. This must be documented.
3. The gas tank will be filled, and all fluids checked at the start of each day.
4. The ATV will be washed down with fresh water at the end of the day.
5. The engine will be sprayed with lubricant weekly to prevent rust and corrosion.

6. All maintenance or mechanical problems must be reported to a lifeguard officer immediately. These problems must be recorded in the daily report and attended to as soon as possible.

#### XIV. MASK, FINS AND SNORKEL

Mask, fins and snorkel can be used separately or together. They are for use in recovering submerged victims or objects.

##### A. Mask

1. Defogging - fogging of mask can be prevented by rubbing saliva on the inside of the face plate, followed by rinsing with water.
2. Proper Fit - Move hair off of face, place mask on face without straps and inhale slightly. If mask stays on face, it is a good fit. If it is a good fit, adjust the straps for the best fit. If it is a poor fit, try again with a different mask.
3. Since all lifeguard diving is done without scuba equipment, the mask can be cleared of any water at the surface.

##### B. Fins

1. Put fins on while in water deep enough to swim in. If you must walk with fins, it is best to walk backwards.
2. Be sure to wear properly sized fins.
3. When kicking with fins, use a modified flutter kick. A modified flutter kick is a flutter kick that is deeper, slower and with more knee bend.

##### C. Snorkel

1. Attach snorkel to side of mask with a clip or by inserting snorkel under mask strap for the stabilization of the snorkel.
2. Hold entire snorkel mouthpiece in your mouth and seal off from water.
3. Breath through snorkel only on the surface.
4. When you surface dive into deeper water with a snorkel, hold breath as if you were diving into deeper water without a snorkel.
5. After surfacing following a dive into deep water with snorkel, the water must be cleared from the snorkel to allow breathing again. Clearing the water from the snorkel is accomplished by exhaling forcefully at the surface. Breathing through snorkel can now be resumed.

D. Pressure Equalization

Diving from the surface to deep water with or without mask, fins and snorkel requires you to equalize pressure within your ears to the pressure of the water outside of your head.

1. The easiest method for equalizing pressure is by squeezing your nose closed through the mask, while closing your mouth and attempting to exhale. If you do not experience equalization, continue until you do so or return to the surface.
2. Equalize as soon as you descend under the water's surface and continue to equalize as you go deeper.

For further information on masks, fins and snorkel, refer to the American Red Cross Lifeguarding textbook, Chapter 10, pages 152-158.

XV. EMERGENCY OXYGEN

- A. Emergency oxygen and related equipment will be stored in the First Aid Room.
- B. It is to be used on a victim who has stopped breathing or having difficulty breathing.
- C. Emergency oxygen is to be used according to the procedures taught in the ASHI Emergency Oxygen course. The course will be taught with the BLS class. Do not administer oxygen if you don't have the class.
- D. The pressure of the cylinder in use will be checked regularly every Thursday. If the pressure is below 500 PSI, the cylinder should be changed. When working on a victim, the cylinder should be changed at about 200 PSI.
- E. All empty or nearly empty cylinders must be given the appropriate personnel Park for prompt refill. Cylinders must be refilled with medical grade oxygen.
- F. Oxygen flow should be used as appropriate for the situation according to ASHI Administering Emergency Oxygen Training
- G. When a victim is transported with mask, request a replacement mask from the ambulance.
- H. Masks and cannulas used on victims must be discarded.

XVI. AUTOMATED EXTERNAL DEFIBRILLATOR (AED)

1. To be stored in first aid room and emergency vehicles.
2. AED to be used according to procedures learned in American Red Cross CPR/AED course. To use an AED your CPR/AED card must be current.
3. Check AED every Monday and record status in the AED log.

# PROCEDURES



## I. OPENING AND CLOSING

- A. All lifeguards are to report to their assigned beach at the designated time. All equipment will be set in place and the beach will be opened.
- B. STATE BATHING AREAS WILL NORMALLY OPEN TO THE PUBLIC AT 10:00 am. The Southern Swimming Area will normally open at 10:30 am. Lifeguards going on duty will call all persons already swimming from the water by whistle blast. Once the water is cleared, a signal horn will indicate that lifeguards are now on duty.
- C. Beach closing procedures will occur in a manner that is consistent with conditions while still providing adequate lifeguard coverage. Lifeguard operations will normally cease at 6:00 PM.
- D. Lifeguards going off duty at the end of the day will call all patrons from the water, signs and flags must be changed, and a horn will sound indicating that lifeguards are off duty.
- E. If the bathing area is closed prior to 6:00 pm the park office must be notified. If the bathing area reopens inform park office.

## II. COMMUNICATIONS

The following signals have been developed so that lifeguards can effectively communicate:

### A. Whistle Signals

- 1. One blast is used for gaining patron's attention.
- 2. Two blasts are used for gaining a lifeguard's attention.
- 3. Three or more rapid short blasts indicate that a rescue is beginning, or other emergency situation exists.

### B. Air Horn Signals

- 1. One blast will be given at the opening and closing of the lifeguard workday or at the changing of public informational flags.

### C. Hand Signals

- 1. A handheld overhead (P-41):

- a. On the beach, it means a lifeguard needs assistance.
  - b. In the ocean, when a lifeguard is on a rescue, it means a lifeguard needs a line buoy or other assistance.
  - c. When the line buoy is being pulled in, it means to stop pulling. If the guard continues to hold his/her hand overhead after the line has stopped being pulled in, other assistance is needed.
2. Moving one arm up and down means victim(s) and rescuer are ready and to pull the line buoy to shore (P-42).
  3. Pointing with index finger extended is used to alert another lifeguard of a situation to be watched in his area (P-43).



**P-41**



**P-42**



**P-43**

**P-44 NO IMAGE**

4. Bring backboard, cervical collars and head immobilizer - move both arms up and down simultaneously above your head as if you were doing presses while weightlifting (P-45).
5. Call an ambulance — Extend your arms perpendicular to the front of your body and move them up and down in an exaggerated imitation of steering a vehicle (P-46).



**P-45**



**P-46**

7. CPR Needed - Bring pocket masks, oxygen equipment, BVM, AED and call an ambulance. Wave one arm overhead. (P-47)



**P-47**

8. Call the State Park Police - Tap top of your head (P-48).
9. To call a lifeguard from the water or to signal a boat or PWC is coming in, blow whistle, move hand in circular motion over your head then motion to come in. (P-49)

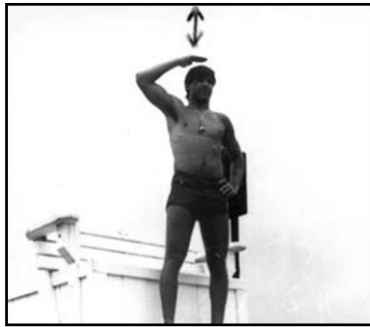

**P-48**



**P-49**

10. Submersion of Victim - lifeguard makes an X with arms overhead (P-49A).
11. All clear – make an O overhead with arms (P-49B).



**P-49A**

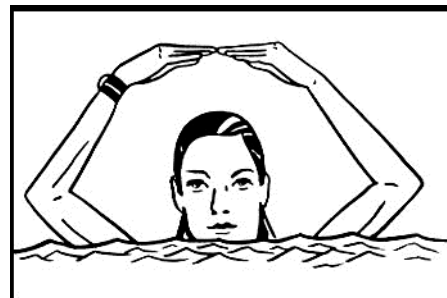

**P-49B**

12. To identify yourself as a lifeguard while in the ocean- Tap your nose with your fingertips.
13. To give directions to a lifeguard in the ocean looking for a victim, or to direct a guard with a victim, the signals are very basic. Point left for the guard to go left, point right for the guard to go right, point out for the guard to go seaward, wave in for the guard to move toward beach and show palms of both hands for the guard to stay.

- D. Radio Procedures: (Refer to Island Beach Lifeguard Radio Procedures)

### III. SUMMONING AID

- A. RADIO — Summon aid as described in the Island Beach Lifeguard Radio Procedures.
- B. PHONE — All emergency telephone numbers should be conspicuously displayed at the telephone. When the aid of an emergency service from outside the area is needed, i.e., ambulance, police, etc., the following steps will be followed.
  - 1. Call the service you need and inform them:
    - a. Who you are and the area you are in.
    - b. The reason you called, the injury or incident and the urgency of assistance.
    - c. The location within the park.
    - d. Your telephone number.
  - 2. Call dispatcher, who will let appropriate area personnel know that an outside agency will be entering the area.

### IV. LOST CHILD/PERSON

When a lost child is brought to a lifeguard stand, the dispatcher should be notified before the procedure below is started. The dispatcher will notify other stands of the lost child:

- A. A complete description of the lost child should be given to the dispatcher who notifies the other units.
- B. The lost child should remain at the lifeguard stand unless, they are escorted by a lifeguard through the beach area.
- C. Everything reasonable should be done by a lifeguard to stabilize the emotional state of the child.
- D. A lifeguard sitting alone should summon help to assist with the lost child. Under no circumstance is a lifeguard to turn his/her back on the bathers leaving them unguarded.
- E. If the above procedure fails to locate the parents, within a reasonable amount of time, the child should be taken to the area office, and the State Park Police will be notified
- F. When the parents have been found, immediately notify dispatcher.

V. MISSING CHILD/PERSON

When someone has been reported missing, the lifeguard should:

- A. Obtain name and complete description.
- B. Find out where the person was last seen.
- C. Ask if the person has any medical condition(s) and obtain any additional information that may aid in locating the person.
- D. Contact dispatcher with information. Dispatcher will then alert other lifeguards, the State Park Police, lifeguard officers and necessary park personnel.
- E. Instruct an adult who knows the child to stay in one location, so they may be contacted as needed.
- G. If the person missing was last seen in the water a lifeguard officer should be summoned immediately to investigate and determine if a water search is necessary.
- H. When the missing person has been found, notify the dispatcher.

VI. RED ALERT - SUBMERSION OF VICTIM

- A. Red alert procedure in designated bathing area

After a lifeguard observes and signals a submerged victim, the dispatcher is notified. The procedure below will be followed:

1. Call to all lifeguards via dispatcher “Red Alert - Stand \_\_\_\_\_” (stand number to be given at time of occurrence).
2. Dispatcher will also contact Superintendent, State Park Police, Senior Lifeguard Officer and assisting agencies. Dispatcher will record chronology of incident.
3. Guards will then:
  - a. Call all patrons out of the water.
  - b. Proceed to designated stand area.
  - c. Carry necessary equipment to designated stand area (masks, snorkels and fins)
  - d. At the stand where submersion occurs, lifeguards take sightings of landmarks (cross bearings) where victim was last seen so the location can be readily identified and marked with a buoy.
  - e. Guards at the stand where submersion occurred and first guards arriving from other stands take random dives until dive lines are formed.
4. The senior lifeguard officer of the area in which the submersion has taken place, will respond to the stand indicated and take charge of the operation. The other officers will report to the scene.
5. The senior lifeguard officer will disperse lifeguards to their assignment in search pattern in the following manner.
  - a. First group of lifeguards arriving will form the North and South diving lines of the pattern.
  - b. If more lifeguards are available the next set of lifeguards to arrive will form the West and East diving lines of the pattern.
6. Senior lifeguard officer will locate diving lines according to the tide, drift and water movement. An officer will place markers to indicate where the dive line started.
7. Each line will have a designated guard in charge who will keep the diving line straight and order it to dive on the command 1-2-3 dive. The dive line will dive and swim along the bottom for a specified distance surface and repeat the procedure until told to change direction by the senior lifeguard officer on the beach.

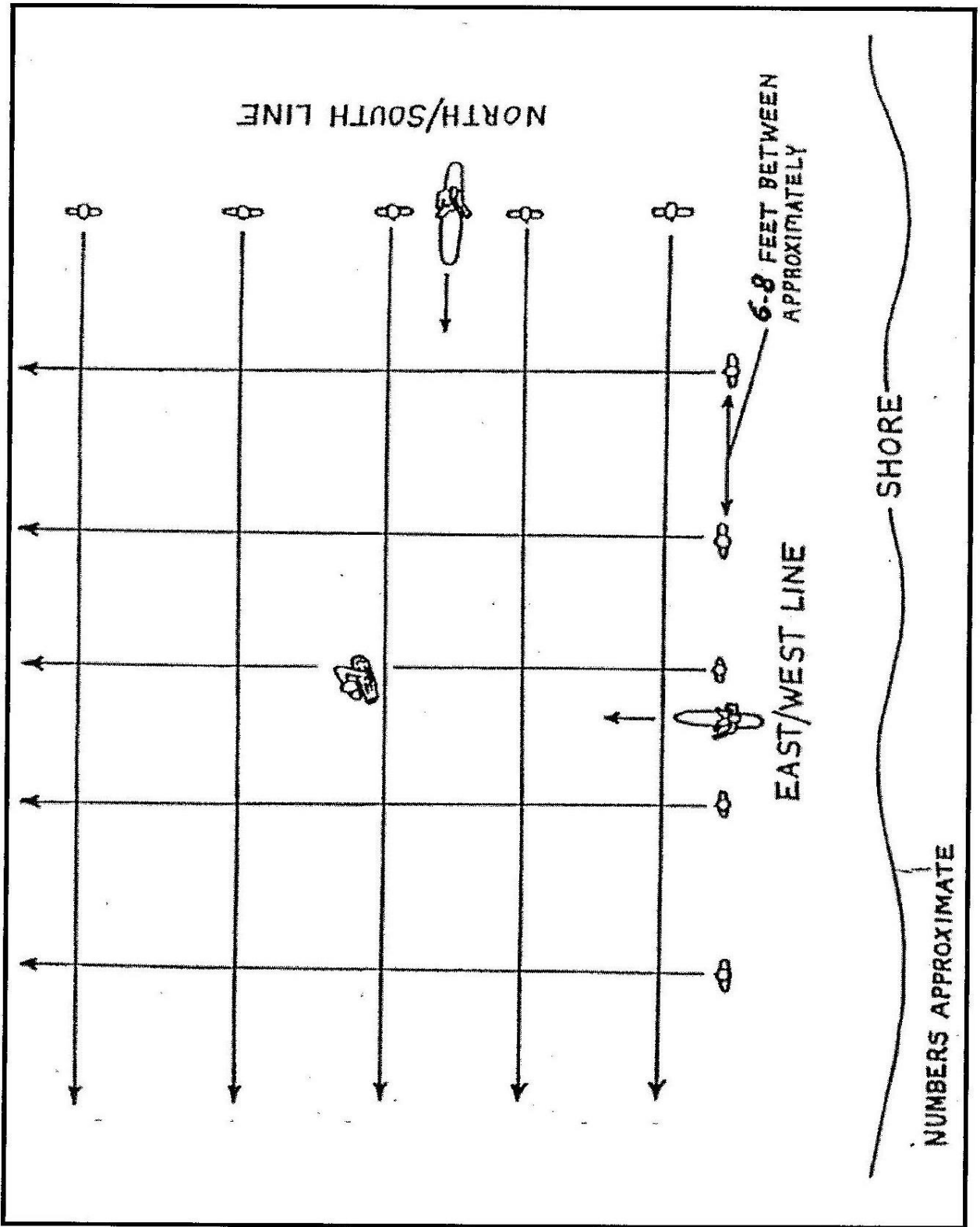



9. Each side of the search pattern may have a guard on board or a kayak. These will come from the stands adjacent to submersion.
10. The senior lifeguard officer will contact all park personnel in the area and instruct them to man the lifeguard stands and keep the patrons out of the water. The lifeguard officer in charge will make note of the time each operation begins and terminates via dispatcher.
11. All first aid personnel will report to the beach with emergency equipment. The other first aid person will remain in his/her room.
12. Only the Area Superintendent may release information regarding the incident.

## VII. OFF-BEACH - RESCUE/FIRST AID

- A. When a call is received that someone needs assistance, not in the bathing beach area, the following steps will be taken:
  1. The dispatcher will notify the senior lifeguard officer and off beach response team (OBRT) that assistance is needed at an off-beach location.
  2. The OBRT (previously assigned by senior lifeguard officer) will proceed to the Lifeguard vehicle, where they will meet a first aid attendant.
  3. The OBRT will proceed at the speed limit to the scene.
  4. PWC OBRT will proceed to the scene via PWC. PWC OBRT is assigned each day by the Senior Lifeguard Officer.
- B. Should the situation develop into a more serious matter, the following steps will be taken:
  1. The dispatcher, upon receiving a call from the OBRT, will call for the appropriate backup.
  2. Lifeguards designated as backup, will then wait in the parking area by the North Pavilion for transportation.
- A. If an off-beach response involves the north jetty, the following precautions must be taken:
  1. Do not walk or swim near the jetty if the prevailing conditions are dangerous.
  2. If a guard must walk on the jetty, to care for a victim, providing it is safe to do so, jetty cleats must be worn on your feet. The jetty cleats allow one to walk without slipping on algae.

3. If a victim is in the water near a jetty the rescuer should try to reach the victim with a PWC, kayak, or by swimming from the shore. A lifeguard should only enter the water from the jetty as a last resort. A victim should never be returned to the jetty.
  - a. If one must enter the water from the jetty, jetty cleats must be worn to the entry point. Go down on the rock as close to the water as possible. Provided the water is deep enough, as the water rises to its highest point from a wave and about to recede, propel yourself into the water headfirst away from the jetty (do not dive deep), with the rescue buoy in front of your head for protection. Swim away from the jetty. Then approach your victim (P-1A and P-1B).



**P-1A**



**P-1B**

#### VIII. DISTURBANCES

Any fight or similar disturbance should be quelled as quickly as possible. When possible, the State Park Police will be notified, and the necessary action left to them. If State Park Police are not available, a team of at least two (2) lifeguards with torpedo buoys should investigate the disturbance. If necessary, troublesome patrons should be asked to leave the beach area. Lifeguards will not attempt to detain patrons. A lifeguard's responsibility is the safety of the bathing area, and this should remain the first priority.

#### IX. LIGHTNING

According to the National Oceanic and Atmospheric Administration there are over 25million lightning strikes a year in the United States. In simple terms, Lightning is described as a "spark" of electricity that occurs when opposite charges in the atmosphere builds up between clouds and/or the ground. Lightning strikes occur at an increased rate during the summer months making lightning a dangerous environmental hazard that should be taken very seriously.

Over 300 hundred people are struck each year and on average, 50 people are killed each year. Many victims are caught off guard or unaware of the risks during a storm and fail to get safely indoors. As a result, precautions should be taken to safeguard both the public and the lifeguard staff when this phenomenon occurs.

As part of the daily routine the following steps should be followed to maximize safety:

1. Prior to coming on duty Lifeguard officers should make note of weather forecasts for the day, specifically noting storm predictions, characteristics and timelines.
2. When storms are predicted, forecasts should be monitored closely throughout the day. Attention should be given to changing weather conditions- changes in cloud formation, darkening skies, changes in wind speed/direction, changes in air temperature and developing precipitation.

(When making the decision to close the beach, lifeguard officers should provide for time required to evacuate the beach safely before the storm hits). Note: it is imperative that Lifeguard officers make every reasonable effort to ensure the safety of the lifeguard staff and public when closing and evacuating the beach.

- a. If thunder is heard, or lightning is seen, the beach should be immediately closed and evacuated.
3. If indications are that a storm is impending, the Superintendent/park office, gatehouse and park police should be notified that the beach will be closing.
  - a. Utilizing whistle blasts, lifeguards should clear the water of all patrons, equipment should be stored and lifeguard stands placed down on their backs.
  - b. Lifeguards should begin to advise patrons on the beach that “a storm is eminent and the beach is closing, please leave the beach and seek shelter”.
  - c. The lifeguard “run truck” should be brought onto the beach to the beach to assist with the evacuation of the beach. Park Police vehicles will also assist with the process.
4. Lifeguards should clear and close the beach as quickly and efficiently as possible and seek shelter in the pavilions, first aid rooms or office at 1-11.
5. The flags should be changed to “Red” and signs should be posted at all paths indicating the beach is closed.
6. Lifeguards will be stationed in sheltered positions to monitor paths and prevent access.

Following protocols recommended by OSHA, the beach shall remain closed for a minimum of 30- 45 minutes after the last sounds of thunder or observed lightning.

## X. GUARDING

- A. The guards are required to provide maximum protection and open the largest portion of the bathing area that is possible based on the number of guards working and prevalent ocean conditions. Maximum service should be provided to the public at all times.

The senior lifeguard officer will make a work schedule for lifeguards to maximize protection and use of the swimming area with consultation of the Superintendent or the Regional Water Safety Supervisor when necessary.

B. When lifeguards arrive on the beach they should immediately make note of water conditions and identify potential hazards. Lifeguards should alert the lifeguard officers to any hazardous situations.

Scanning - (Diagram on following page):

C. Scanning is the method used for watching the bathers in an assigned area. Starting at one end of the area, work across to the other end, looking at each bather for a brief moment, making note of anyone who could possibly have trouble in the next few moments. On the next sweep across the area, re-evaluate each bather previously noted, and take note of other bathers that now have given an indication that they may become a problem. While scanning, overlap your area with adjacent area, and keep an eye on adjacent lifeguard stands. When a lifeguard is relieved, or moved to another position, they must inform their replacement of the bathers that may become a problem.

1. A few things to watch for while scanning:

- a. Poor swimmer
- b. Swimmers becoming tired or weak
- c. Unattended children
- d. People who are knocked over by waves
- e. Rule violators
- f. Unnatural or excessive splashing with arms
- g. Poor swimmers going out over their heads
- h. People in the water with street clothes on
- i. People possibly under the influence of alcohol
- j. Body boards without leash
- k. Drop offs or holes
- l. Rip currents
- m. Fringe of main bathing crowd
- n. Backwash
- o. Drift
- p. Sandbars
- q. Hole between bar and beach
- r. Hazards

# GUARDS SCANNING THE BATHING AREA

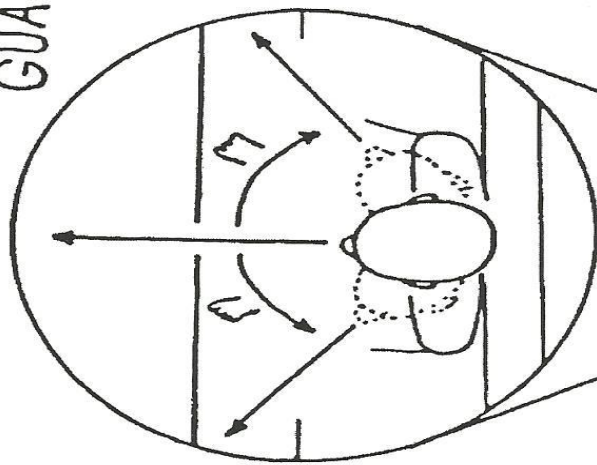

KAYAK

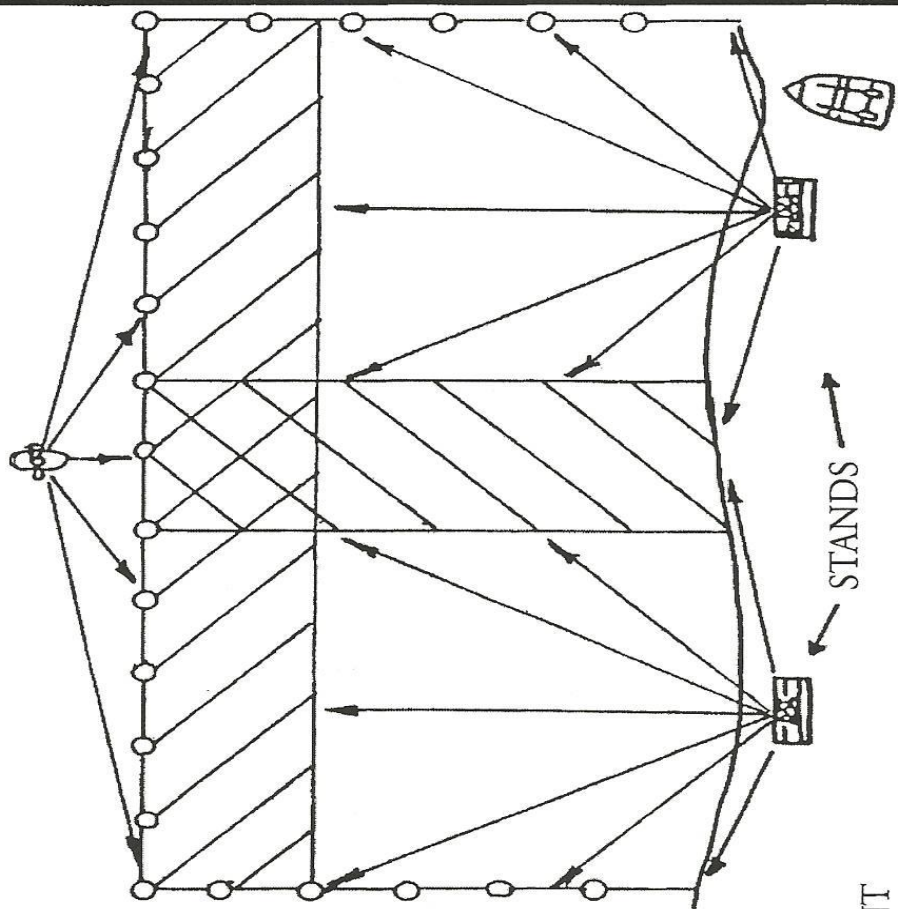

COVERED WHERE ADJACENT STANDS OVERLAP

COVERED WHERE STANDS AND KAYAK OVERLAP

BEACH

STANDS

2. While scanning, an alert lifeguard will recognize a patron getting close to a rip current, attempting to swim across a hole between beach and bar with poor swimming ability and other actions dangerous to their welfare or that violate regulations. The lifeguard sighting an unsafe situation or rule breakers should stand up, get the patrons attention with one whistle blast, and warn the patron to prevent serious problems.
3. A guard must recognize a red and white divers' flag if displayed and ascertain through the chain-of-command if a diving permit has been issued by the area office. If in a lifeguard craft, stay 50 feet from the flag. A diver holding one hand over head means a diver needs assistance.

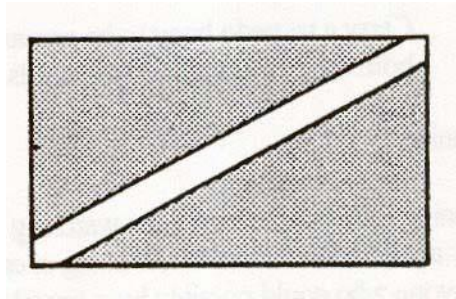

**RED AND WHITE  
DIVERS FLAG**

4. A bather with one hand raised above his/her head is requesting assistance. This sign is the universal symbol for help in the aquatic environment.

## XI. RESCUE PROCEDURE AND COVERAGE:

- A. Rescue with free buoy and line buoy: this is the most common rescue at Island Beach. When possible, a team of two lifeguards should perform most rescues to assist each other if the situation merits.
1. When a potential victim is spotted, the lifeguard will make a determination if a rescue is necessary and which equipment should be used
  2. On the decision to “go,” lifeguards will blow three or more short whistle blasts until they reach the water.
  3. Lifeguards on the rescue will maintain visual contact with the victim to the best extent possible.
  4. The point of entry will be determined by prevailing water movement.
  5. Lifeguards on stands adjacent to rescue will cover or stand up on their stands.
  6. A covering guard may have to scan from the stand, assist rescue or feed line for the line buoy swimmer, if needed.
  7. Lifeguard feeding the line does so from shallow water. Feed the line over your head while keeping the line taut.
  8. Lifeguard that arrives to victim first will pass buoy to victim (P-50).



**P-50**

9. a. The lifeguard will then place the buoy diagonally in front of the victim with the lifeguard's arms passing under the victim's arms, which will “sandwich” the victim safely between the buoy and lifeguard. The victim's arms should be allowed to rest freely over the buoy.
- b. If the line buoy is not following, the lifeguard should signal for a line buoy

and then get towed to shore.

- c. Caution should be exercised in keeping the victim's face free of water if the victim is unconscious (P-51).
- d. If a line buoy is not needed, the victim can just hang on the buoy, if strong enough, and the lifeguard can tow the victim on the buoy to shore (P-52).



10. When the line buoy swimmer arrives, they should render whatever assistance is necessary in securing the free buoy and the victim to the line buoy (P-53).



11. When all are prepared for the tow or "pull," the line swimmer shall pump one arm up and down as a signal to the guard on shore to begin the pull (P-54).





12.
  - a. The pull may be halted at any time by extending an arm overhead. If resuscitation equipment is needed it may be signaled for from the water, so it will be available for use when the victim is brought ashore.
  - b. The line pullers on shore shall face the water at all times. The line should be placed around the buttocks and pulled by backing up the beach. This will allow the pull to be a smooth action, and the line to fall in a neat manner, which will allow the line to be immediately used again, if necessary, with a minimum of fouling. Remember, the line puller should never take his/her eyes off the rescue team. The line should be pulled in a smooth, even manner.
13. When the guards and victim are close enough to shore that they may easily stand, the guards will carry or assist the victim ashore. All victims regardless of condition shall be held securely by the lifeguard until the victim is completely free of the water. Under no circumstances will a victim be allowed to proceed ashore unassisted once rescue procedures are in effect.

Assisting a conscious victim to shore (P-55).



**P-55**

- b. Chair carry used by two lifeguards to bring victim ashore (P-56, P-57).



**P-56**

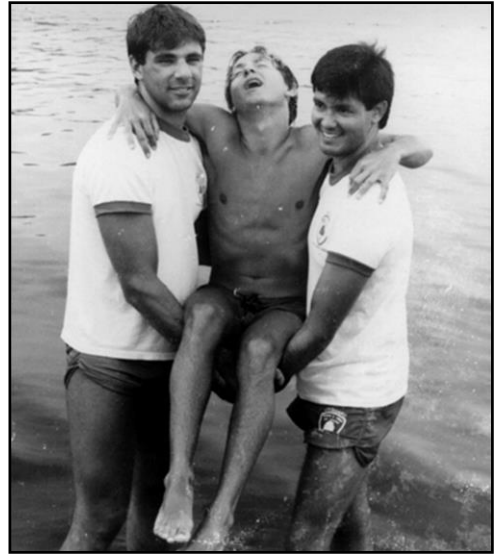

**P-57**

- c. A victim is dragged to shore if it is necessary for one lifeguard to remove an unconscious victim from the water, however, the chair carry is preferred (P-58).



**P-58**

14. **AN AMBULANCE WILL BE CALLED FOR ANY VICTIM WHO HAS LOST CONSCIOUSNESS AT ANY TIME DURING A RESCUE OR HAS TAKEN IN WATER. (NEAR DROWNING)**

- B. Stand Coverage

Lifeguards from other stands cover for lifeguards who leave the stand for a rescue or other emergency in the following manner:

1. One Lifeguard from an adjacent lifeguard stand will run with torpedo buoy to vacated stand and assume responsibility for that stand. If the covering guard must assist in the emergency, he should blow rescue whistles so another guard from an adjacent stand can cover.
2. If the guard going to cover a stand with an emergency leaves his stand empty, the guard must whistle down to the next stand for a guard to cover his stand. This procedure continues until coverage is complete.
3. Lifeguards not participating in the rescue must be sure to scan the bathing area extra carefully at these times because:
  - a. There is a decrease in the number of lifeguards watching the bathers.
  - b. Everyone's attention is on the rescue, and people may tend to forget about the children or poor swimmers they are with.
  - c. The possibility exists that a bather in another part of the bathing area may get into difficulty during the rescue.
4. . IF A RESCUE OR BEACH EMERGENCY REQUIRES ALL LIFEGUARDS TO LEAVE A STAND WITH NO BACKUP COVERAGE, THE BATHING AREA MUST BE FIRST CLEARED OF ALL BATHERS.

C. First Aid Room Coverage

Lifeguards will be asked to cover First aid Room when first aid person must leave.

1. Lifeguard will be notified by radio to cover First Aid Room. This lifeguard will come from a stand with 2 lifeguards so further coverage is not necessary. Covering lifeguard must monitor communications of first aid person.
2. Lifeguard may be notified by radio to assist first aid person in carrying first aid equipment.

ALL RESCUE PROCEDURES AND COVERAGES WILL BE PRACTICED BY ALL LIFEGUARDS DURING IN-SERVICE TRAINING.

## XII. MISCELLANEOUS HAZARDS

### **Marine Hazards**

1. Lifeguards should be alert for hazards such as bluefish, sharks, other dangerous aquatic life, floating debris, and chemicals and other dangerous aquatic life.
2. Jelly fish encountered in New Jersey usually only cause slight skin irritation for less than one hour. But be aware that on rare occasions, an allergic reaction occurs requiring

more advanced are. Washing irritated skin with seawater helps. A half hour usually relieves the pain.

3. Fuel spills from planes and boats are toxic. One should not enter the ocean without protection.
4. Floating debris hazards pose an additional risk of injury. Pilings, large floating debris generated by off coast storms can be found drifting into the swim area. Upon recognizing a potential hazard, it should be reported to the senior lifeguard officer. Senior lifeguard officer will decide if water should be cleared of patrons.

## **Hole Hazards**

Although a lifeguard's primary responsibility is watching the water and protecting patrons from dangerous water conditions, they should also be aware of the surrounding environment. This includes the surrounding beach area and since lifeguards have complete authority and responsibility for the bathing area assigned to them, attention should be given to non-water hazards. Lifeguards should survey the surrounding beach for issues that are potentially dangerous to patrons.

### **Holes and Digging**

Lifeguards are often involved in issues related to holes dug by patrons. Holes pose several issues on the beachfront. Unwary patrons can step in holes causing varying degrees of injury. They also pose a cave in threat to patrons (especially small children) when dug too deeply. On many occasions, lifeguards have been called to assist when the hole has caved in trapping a patron. Often holes are dug and abandoned once the person tires of the digging process.

For these reasons, the following protocols are advised:

1. If a lifeguard observes a patron digging a deep hole they should advise the patron not to dig holes beyond knee deep. It is also advisable to inform them that holes should wider than they are deep.
2. When practical, patrons should be expected and advised to fill in holes when they are finished. If a lifeguard sees an abandoned hole, they should make every effort to fill in the hole as soon as possible.
3. A lifeguard should not let holes be dug in the area adjacent to or in front of a lifeguard stand.
4. Deep holes should not be dug or sat in along the water line. Incoming wave action can fill in the hole quickly and wet sand becomes "cement- like," making it difficult to assist anyone trapped.

Assisting or responding to cave in:

When responding to an emergency involving a cave in the following procedures should be followed:

1. The first lifeguard on scene should get as much information as possible, including the location, number of people involved and approximate depth of the hole.
2. Dispatch should be notified.
  - a. Dispatch should notify an EMT and area officer to respond.

- b. Dispatch should call for an ambulance.
3. Responding lifeguards should report to the area and begin a systematic digging process. (No shovels / digging instruments should be used.) To prevent further cave ins- the number of lifeguards digging should be determined by the OIC. Care must be given to prevent further cave ins while digging.
4. Remaining lifeguards should set a perimeter to keep other patrons clear of the area. (Only lifeguard personnel should be involved with the response and rescue).
5. Depending on the depth of the hole, a parallel hole should be dug to assist with removing sand from the primary hole.
6. The responding EMT should prep an area for medical support and provide appropriate assistance once the patron has been removed from the hole.
7. Upon recognizing a potential hazard, it should be reported to the senior lifeguard officer.  
Senior lifeguard officer will decide if water should be cleared of patrons.

### XIII. RESCUES WITHOUT LIFESAVING EQUIPMENT

The USLA and the American Red Cross do not recommend rescues without equipment when lifesaving equipment is available. A State Park Service lifeguard should attempt a water rescue, with available equipment. However, A guard is to learn the following skills in case a guard gets caught in a rescue situation without equipment or the equipment taken for the rescue malfunctions.

#### A. Non-Equipment Rescue Skills

1. Approaches
  - a. Rear (Swim and Dive)
  - b. Front surface
  - c. Submerged victim
2. Level Offs
  - a. Single armpit
  - b. Double armpit
3. Carries and Tows
  - a. Cross-chest
  - b. Control cross-chest
  - c. Single and double armpit tows
  - d. Armpit assist for tired swimmers with one or two lifeguards
  - e. Wrist tow
4. Defenses
  - a. Block and approach victim again
5. Releases and Escapes
  - a. Front head hold
  - b. Rear head hold
  - c. Double drowning release

d. Wrist grip

These skills will be taught and tested according to the methods discussed in Chapter 9 page 137 of the American Red Cross Lifeguarding Textbook. When learning or reviewing these skills, the Lifeguarding Textbook must be consulted.

# **OCEAN AND BEACH TERMINOLOGY**

## I. OCEAN WATER TERMINOLOGY:

The following are terms that are encountered in the daily routine of lifeguarding at an ocean area:

- A. Sandbar - Island of sand submerged or visible inside the surf line.
- B. Drift - A current parallel to the beach created by the wind, a rip feeder, or waves.
- C. Rip Current — Sometimes named a “sea puss” or misnamed undertows. It is a continuous flow of water seaward through the surf zone, at a break in a sandbar. They are strong enough to pull even experienced swimmers away from shore. They are the most common reason for rescues at Island Beach State Park. This often happens where currents moving parallel to shore in opposite directions meet and the water from the waves returns to sea between two sandbars (2 feeder rips). Rips can extend as far as 3000 feet offshore, and reach 90 feet in width, and travel up to 4 feet per second.

### 1. Recognizing a rip current

- a. A change in water color from surrounding water, (either murkier from sediments or greener from greater depth). P-1
- b. An agitated appearance, with white caps extending beyond the breaker zone.
- c. A gap in advancing breakers, where the rip current is forcing its way seaward. P-2
- d. A foam line.
- e. Floating objects that move steadily seaward.



**P-1**



**P-2**

### 2. Advantages of rip current

- a. A fast way to get to a victim.
- b. Safe way in and out with boats and kayaks/rescue boards.

### 3. Escaping a Rip Current

A swimmer should swim parallel to the beach, until out of the rip, or allow the rip to take the swimmer out past the sand bar where the rip disburses and then swim parallel to shore until free of rip. Whenever possible, patrons should not be allowed to swim



near a rip. Lifeguards must be extremely alert to the danger caused by a rip.

D. Traveling Rips

Traveling rips are less intense rip currents and are sometimes referred to as sand pusses. They are less intense because they do not involve a break in the sand bar and move the water a shorter distance seaward. They occur along the shoreline or off the back of a sandbar. They are not stationary as a larger 2-feeder rips. Their location often moves resulting in the name traveling rip. Traveling rips are dangerous because their location cannot be predicted as with a 2-feeder rip.

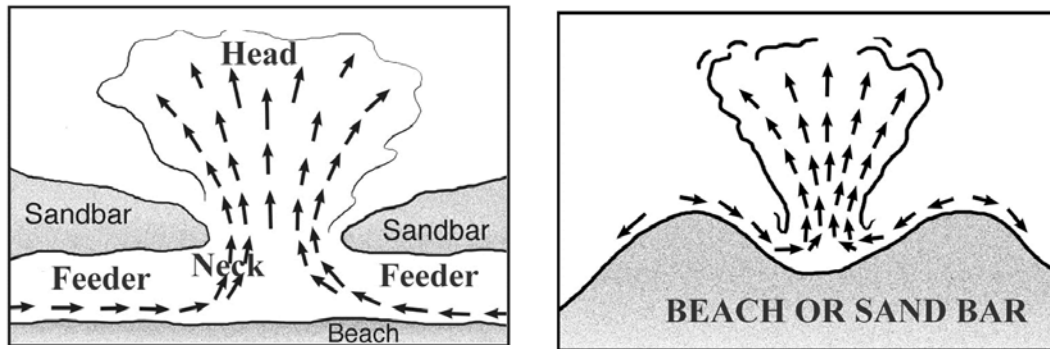

- E. Shore Break — A shore break is the breaking of waves on the immediate beach area. They are usually of a curling or dumping nature and occur most commonly during high tide. Unusually high shore breaks are not uncommon when a strong westerly wind prevails, allowing the wave to continue to build as the wind holds the face up longer than normal. They can be very dangerous to patrons, especially in the surf mat area.
- F. Spilling Breaker — A spilling breaker is a long wave that breaks offshore. The break starts at the top of the wave, and continues down the front in a smooth, even fashion. A hollow is not formed between the breaking water, and the main body of the wave. These waves are the best type for surf mats, body boards, and body surfing.
- G. Offshore Break — An offshore break is the breaking of waves out from the beach, at least 75 yards. This is usually caused by the wave breaking on an offshore sandbar and is most common during low tide.
- H. Plunging Breaker — A plunging breaker is a wave characterized by a hollow forming between the breaking water, and the main body of the wave. The top of the wave often breaks almost straight down. The top of the initial break usually contains one-third of the volume of the wave. The break is tremendously forceful, and can be very dangerous to patrons, especially when it occurs on shore during high tide. This kind of wave is created by a west wind.
- I. Backwash — The action of water close to the shore returning to where it came from. Strongest when the beach shelves off sharply. Do not resist; be carried out, return to shore.
- J. Surf Line — Farthest distance from shore where waves begin to break.
- K. Surf Zone — Area where waves are breaking.

- L. Outside — Ocean, seaward of surf line.
- M. Tide — The periodic rising and falling of water resulting from the gravitational attraction of ocean by the moon and sun.
- N. White Caps — Windblown chop that has white foam on top. White caps are caused by winds of 15 knots or more.
- O. Set — Series of waves.
- P. On Shore Wind — A wind blowing from sea to land (East).
- Q. Offshore Wind — A wind blowing from land to sea (West).
- R. Lull — Period of slack water between sets of waves.



New Jersey Department of Environmental Protection  
Division of Parks and Forestry  
State Park Service  
PO Box 420  
Mail Code 501-04  
Trenton, NJ 0862509420



I certify that I have read and understand the New Jersey State Park Service Lifeguard Manual for State Operated Ocean Beaches dated May 2021.

**Name:** \_\_\_\_\_

**Signature:** \_\_\_\_\_

**Date:** \_\_\_\_\_

**SPS Area:** \_\_\_\_\_